

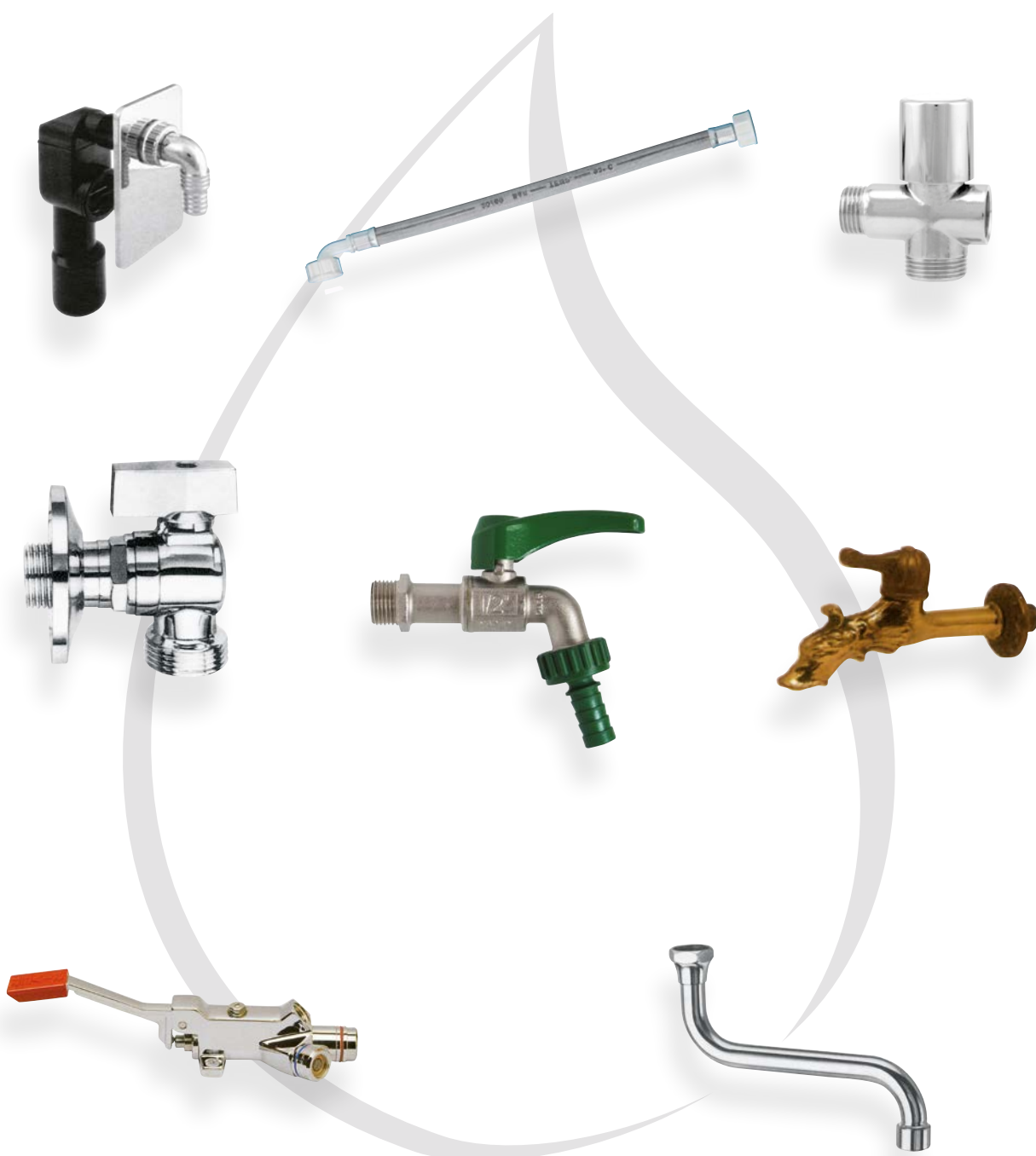

Rubinetti lavatrice • Tubi lavatrice  
Rubinetti lavello • Rubinetti temporizzati



art. **705** 

Sifone ad incasso per lavatrice e lavastoviglie in PEHD nero a saldare, Ø 40, con piastra ABS bianca.



art. **705A** 

Idem con piastra ABS cromata.

art. **705R**

Solo piastra ricambio.

art. **705AR**

Solo piastra ricambio.

art. **705LX** 

Sifone incasso lavatrice maggiorato in PP Ø 40/50 con placca bianca o cromata.



art. **705IX**

Sifone ad incasso per lavatrice e lavastoviglie in PP nero a saldare, Ø 40, con piastra inox.



art. **705IX**

Sifone incasso lavatrice maggiorato in PP Ø 40/50 con placca inox.



art. **705PL**

Sifone ad incasso per lavatrice e lavastoviglie in PP nero a saldare, Ø 40, con piastra bianca.



art. **705PL**

Sifone ad incasso per lavatrice e lavastoviglie in PP nero a saldare, Ø 40/50, con piastra bianca.

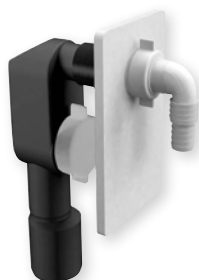

art. **1120**

Sifone ad incasso per lavatrice in PEHD nero ad innesto, Ø 40, completo di box con placca bianca.



art. **1120A**

Idem con placca cromata.

art. **1120R01**

Piastra ABS bianca.

art. **1120AR01**

Piastra ABS cromo.

cod. art.	mis.	€	conf.
-----------	------	---	-------

00705.000		10,663	25
0705A.000		18,562	25

00705.R02	bianca	2,761	10
0705A.R02	cromo	19,329	10

705LX.BIA		10,800	10
705LX.CRO		19,555	10

705IX.400	Ø 40	8,254	10
-----------	------	-------	----

705IX.500	Ø 40/50	9,004	10
-----------	---------	-------	----

705PL.400	Ø 40	7,503	10
705PL.500	Ø 40/50	8,254	10

01120.000		14,961	1
1120A.000		23,702	1
01120.R01		9,444	1
1120A.R01		24,340	1

**art. 1121**

Sifone ad incasso per lavatrice in PEHD nero c/cod. in PVC bicchiere, completo di box c/ placca bianca.

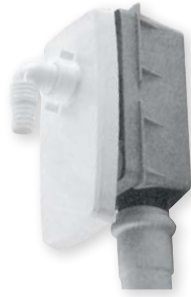
**art. 1121A**

Idem con placca cromata.

**art. 705DO** 

Sifone lavatrice doppio lavatrice / asciugatrice

**art. 707**

Prolunga filettata per allungare il bocchettone del sifone lavatrice da incasso dado 1".

**art. 708**

Sifone lavatrice esterno con valvole di non ritorno in PP/ABS colore bianco.

**art. 709**

Idem come sopra cromato.

**XLIRA**
**art. 704**

Sifone salvaspazio esterno ispezionabile con potragomma per lavatrice/asciugatrice.

**art. 708DO**

Sifone doppio scarico lavatrice con dispositivo di non ritorno.

**art. 269**

Attacco doppio per scarico lavatrice e asciugatrice, dado da 1" Sistema con valvole antiritorno

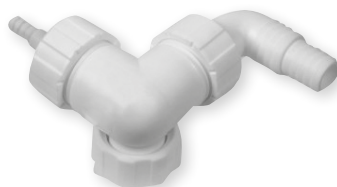

cod. art.	mis.	€	conf.
01121.000		17,716	1
1121A.000		26,616	1
<hr/>			
705DO.000		67,496	1
<hr/>			
00707.000		4,346	10
<hr/>			
00708.000		8,054	10
00709.000		12,426	10
<hr/>			
00704.000	1" 1/2 Ø40	26,756	10
<hr/>			
708DO.000		28,454	10
<hr/>			
00269.000		29,805	10

art. **269 BO**



Attacco doppio per scarico lavatrice e asciugatrice in polipropilene, dado da 1"

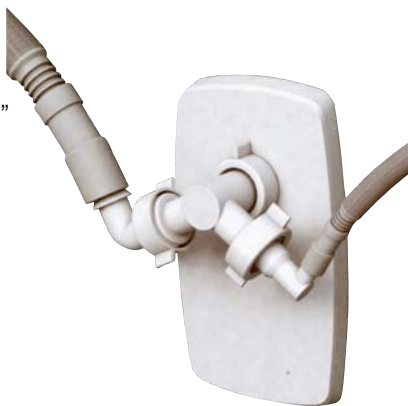

cod. art.	mis.	€	conf.
-----------	------	---	-------

<b>269BO.BON</b>		<b>11,454</b>	10
------------------	--	---------------	----

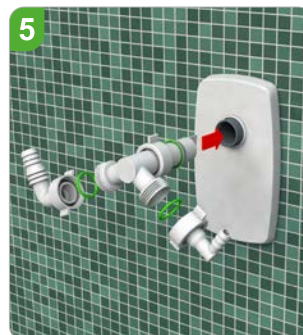

art. **269DO**

Raccordo doppio per due lavatrici o lavatrice/asciugatrice.



<b>269DO.DOP</b>		<b>12,450</b>	10
------------------	--	---------------	----

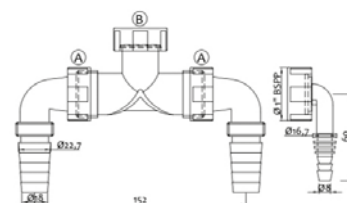

art. **535**

Sifone rapido per scarico lavatrice e lavastoviglie.



<b>00535.000</b>		<b>27,112</b>	6
------------------	--	---------------	---

11

art. **270**

Dado e curveta in ABS per sifone lavatrice.



<b>00270.BIA</b>		<b>1,267</b>	12
<b>00270.CRO</b>		<b>2,218</b>	12

art. **272 BO**



Attacco portagomma curvo per asciugatrice attacco filettato da 1" bianco.

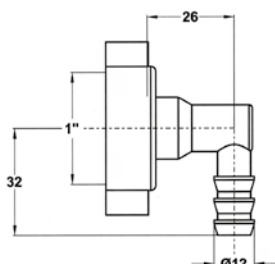

<b>272BO.ASC</b>		<b>3,602</b>	10
------------------	--	--------------	----

**art. 2690T**

Curveta scarico lavatrice /asciugatrice in ottone cromato



**PORTAGOMMA  
REVERSIBILE  
DX/SX  
Ø 8 mm**

cod. art.	mis.	€	conf.
2690T.000		27,721	6

**art. 276**

Giunto per carico lavatrice in nylon.



00276.000		0,389	50
-----------	--	-------	----

**art. 277**

Giunto per scarico lavatrice in nylon.



00277.000	17-17	0,389	50
00277.001	17-22	0,389	50
00277.002	22-22	0,389	50

**art. 278**

Guarnizione lavatrice in gomma.



00278.000	3/4	8,186	(x100)
-----------	-----	-------	--------

**art. 790**

Pipa con ghiera girevole con filetti da 3/4M a 3/4F, (per tubi carico).



00790.000		2,612	50
-----------	--	-------	----

**art. 883**

Raccordo a Y per tubi carico lavatrice e lavastoviglie.



00883.000		3,057	10
00884.000		1,056	10

**art. 884**

Idem per tubi scarico lavatrice.

**art. 882**

Guarnizione con filtro.



00882.000	3/4"	0,584	50
00882.102	1/2"	0,500	50

### art. 279

Tubo carico lavatrice in PVC con raccordi nylon F.F. 3/4 con guarnizioni inserite



### art. 2790T

Tubo carico lavatrice in PVC con raccordi in ottone F.F. 3/4 con guarnizioni inserite



### art. 280

Tubo carico lavatrice in PVC con raccordi nylon M.F. 3/4 con guarnizioni inserite



### art. 280A

Tubo carico lavatrice in PVC con curva raccordi nylon F.F. 3/4 con guarnizioni inserite



### art. 280-OT

Tubo carico lavatrice in PVC con curva raccordi in ottone F.F. 3/4 con guarnizioni inserite



### art. 279NY

Tubo carico lavatrice in treccia nylon con raccordi in ottone FF 3/4 con guarnizioni inserite.



cod. art.	mis.	€	conf.
00279.001	cm. 100	<b>3,739</b>	10
00279.002	cm. 150	<b>4,281</b>	10
00279.003	cm. 200	<b>5,256</b>	10
00279.004	cm. 250	<b>6,299</b>	10
00279.005	cm. 300	<b>7,274</b>	10

#### SCHEDA TECNICA

Pressione d'esecuzione: 10 bar

Pressione di scoppio: 60 bar

<b>2790T.001</b>	cm. 100	<b>6,174</b>	10
<b>2790T.002</b>	cm. 150	<b>6,724</b>	10
<b>2790T.003</b>	cm. 200	<b>7,699</b>	10
<b>2790T.004</b>	cm. 250	<b>8,737</b>	10
<b>2790T.005</b>	cm. 300	<b>9,713</b>	10

#### SCHEDA TECNICA

Pressione d'esecuzione: 10 bar

Pressione di scoppio: 60 bar

00280.001	cm. 100	<b>3,739</b>	10
00280.002	cm. 150	<b>4,281</b>	10
00280.003	cm. 200	<b>5,256</b>	10
00280.004	cm. 250	<b>6,299</b>	10
00280.005	cm. 300	<b>7,274</b>	10

#### SCHEDA TECNICA

Pressione d'esecuzione: 10 bar

Pressione di scoppio: 60 bar

0280A.001	cm. 100	<b>3,810</b>	10
0280A.002	cm. 150	<b>4,364</b>	10
0280A.003	cm. 200	<b>5,336</b>	10
0280A.004	cm. 250	<b>6,386</b>	10
0280A.005	cm. 300	<b>7,320</b>	10

#### SCHEDA TECNICA

Pressione d'esecuzione: 10 bar

Pressione di scoppio: 60 bar

<b>2800T.001</b>	cm. 100	<b>6,257</b>	10
<b>2800T.002</b>	cm. 150	<b>6,807</b>	10
<b>2800T.003</b>	cm. 200	<b>7,774</b>	10
<b>2800T.004</b>	cm. 250	<b>9,870</b>	10
<b>2800T.005</b>	cm. 300	<b>9,758</b>	10

#### SCHEDA TECNICA

Pressione d'esecuzione: 10 bar

Pressione di scoppio: 60 bar

<b>279NY.001</b>	cm. 100	<b>14,356</b>	10
<b>279NY.002</b>	cm. 150	<b>16,701</b>	10
<b>279NY.003</b>	cm. 200	<b>19,013</b>	10
<b>279NY.004</b>	cm. 250	<b>21,501</b>	10
<b>279NY.005</b>	cm. 300	<b>22,422</b>	10

#### SCHEDA TECNICA

Pressione d'esecuzione: 10 bar

Pressione di scoppio: 60 bar



**art. 280NY**

Tubo carico lavatrice in treccia nylon con curva - raccordi in ottone FF 3/4 con guarnizioni inserite.



cod. art.	mis.	€	conf.
<b>280NY.CU1</b>	cm. 100	<b>18,020</b>	10
<b>280NY.CU2</b>	cm. 150	<b>20,651</b>	10
<b>280NY.CU3</b>	cm. 200	<b>23,264</b>	10
<b>280NY.CU4</b>	cm. 250	<b>25,882</b>	10
<b>280NY.CU5</b>	cm. 300	<b>28,504</b>	10

**SCHEDA TECNICA**

Pressione d'esecuzione: 10 bar

Pressione di scoppio: 60 bar

<b>00275.150</b>	cm. 150	<b>31,125</b>	4
------------------	---------	---------------	---

**SCHEDA TECNICA**

Temperatura di utilizzo: max 80°

Pressione d'esecuzione: 0,2-10 bar

Pressione di scoppio: 60 bar

<b>280BO.RSA</b>		<b>0,556</b>	1
------------------	--	--------------	---

**art. 275**

Tubo carico lavatrice/lavastoviglie con sicurezza acquastop

**art. 280B0**

Per tubi carico/scarico lavatrice confezionati in borsa.

**art. 279A**

Tubo carico lavatrice in treccia acciaio inox con raccordi in ottone FF 3/4 con guarnizioni inserite.



<b>0279A.001</b>	cm. 100	<b>16,770</b>	5
<b>0279A.002</b>	cm. 150	<b>20,505</b>	5
<b>0279A.003</b>	cm. 200	<b>24,240</b>	5
<b>0279A.004</b>	cm. 250	<b>27,975</b>	5
<b>0279A.005</b>	cm. 300	<b>31,722</b>	5

**SCHEDA TECNICA**

Temperatura: -5°C / +90°C

Raggio curvatura: 45 mm

Pressione d'esecuzione: 10 bar

Pressione acqua: 75 L/min

<b>0280C.001</b>	cm. 100	<b>20,505</b>	5
<b>0280C.002</b>	cm. 150	<b>24,240</b>	5
<b>0280C.003</b>	cm. 200	<b>27,975</b>	5
<b>0280C.004</b>	cm. 250	<b>32,239</b>	5
<b>0280C.005</b>	cm. 300	<b>35,645</b>	5

**SCHEDA TECNICA**

Temperatura: -5°C / +90°C

Raggio curvatura: 45 mm

Pressione d'esecuzione: 10 bar

Pressione acqua: 75 L/min

**art. 280C**

Tubo carico lavatrice in treccia acciaio inox con curva raccordi in ottone FF 3/4 con guarnizioni inserite.

**art. 999**

Tubo per scarico lavatrice e lavastoviglie in polipropilene copolimero allungabile (testato a -20°C. e a + 100°C.), completo di manicrotti in gomma grigia.



<b>00999.001</b>	cm. 50/200	<b>4,910</b>	10
<b>00999.002</b>	cm. 60/300	<b>5,280</b>	10

### art. 992

Tubo scarico per lavatrice a spirale  
con manicotti Ø 19 e Ø 21  
Testato -20°C +100°C



cod. art.	mis.	€	conf.
00992.001	cm. 100	1,701	10
00992.002	cm. 150	1,951	10
00992.003	cm. 200	2,351	10
00992.004	cm. 250	2,751	10
00992.005	cm. 300	3,151	10
00992.006	cm. 350	3,552	10

### art. 992G

Tubo scarico lavatrice  
con manicotti Ø 19 e Ø 25  
Testato -20°C +100°C



0992G.150	150 cm	2,051	10
0992G.200	200 cm	2,451	10
0992G.250	250 cm	2,851	10
0992G.300	300 cm	3,251	10

### art. 992C

Tubo scarico lavatrice con manicotto  
gomito Ø 22 e diritto Ø 19  
Testato -20°C +100°C



0992C.150	150 cm	2,451	10
0992C.200	200 cm	2,951	10
0992C.250	250 cm	3,452	10
0992C.300	300 cm	3,952	10

### art. 992PR

Prolunga tubo scarico lavatrice a spirale  
con giunto Ø 19  
Testato -20°C +100°C



992PR.150	150 cm	3,301	10
-----------	--------	-------	----

### art. 991

Rotolo da mt. 50, tubo scarico per  
lavatrice .



00991.000		1,867	50
-----------	--	-------	----

### art. 993

Manicotto in gomma filettata.



00993.GRA	Ø 21	1,401	25
00993.PIC	Ø 19	1,401	25

### art. 994

Curva in plastica per tubo scarico lavatrice.



00994.000		0,300	10
-----------	--	-------	----



**art. 282CF**

Scatola con 34 pezzi assortiti di fascette stringitubo nelle seguenti misure: (Ø10-16mm) - (Ø12-1mm) - (Ø16-25mm) - (Ø18-28mm) - (Ø20-32mm) - (Pezzi n.8) - (Pezzi n.8) - (Pezzi n.6) - (Pezzi n.4) - (Pezzi n.4) - (Pezzi n.4)



cod. art.	mis.	€	conf.
<b>282CF.000</b>		<b>25,611</b>	1

**art. 282AC**

Fascetta stringitubo acciaio inox 430



<b>282AC.008</b>	8 - 19	<b>9,738</b>	(x 100)
<b>282AC.012</b>	12 - 24	<b>11,827</b>	(x 100)
<b>282AC.017</b>	17 - 29	<b>11,872</b>	(x 100)
<b>282AC.025</b>	25 - 45	<b>6,225</b>	(x 50)
<b>282AC.033</b>	33 - 53	<b>7,114</b>	(x 50)
<b>282AC.040</b>	40 - 60	<b>7,114</b>	(x 50)
<b>282AC.048</b>	48 - 68	<b>7,114</b>	(x 50)
<b>282AC.063</b>	63 - 83	<b>7,337</b>	(x 50)
<b>282AC.078</b>	78 - 98	<b>7,781</b>	(x 20)

**art. 281NY**

Fascetta in Nylon nera (euro per confezione 100 pz)



<b>281NY.100</b>		<b>6,948</b>	(x 100)
<b>281NY.140</b>		<b>7,642</b>	(x 100)
<b>281NY.165</b>		<b>8,337</b>	(x 100)
<b>281NY.203</b>		<b>10,421</b>	(x 100)
<b>281NY.250</b>		<b>11,811</b>	(x 100)
<b>281NY.350</b>		<b>12,506</b>	(x 100)
<b>281NY.190</b>		<b>12,506</b>	(x 100)
<b>281NY.360</b>		<b>16,674</b>	(x 100)

**art. 283 **

Rubinetto verticale attacco lavatrice.



<b>00283.002</b>	1/2"x3/4"	<b>13,168</b>	20
------------------	-----------	---------------	----

**art. 283X**

Rubinetto a squadra per lavatrice chiusura vitone in ottone cromato.



<b>00283X.000</b>	1/2"x3/4"	<b>8,095</b>	20
-------------------	-----------	--------------	----

**art. 284 **

Rubinetto a squadra attacco lavatrice.



<b>00284.002</b>	1/2"x3/4"	<b>13,869</b>	10
------------------	-----------	---------------	----

art. **284X**

Rubinetto diritto per lavatrice chiusura vitone in ottone cromato.



cod. art.	mis.	€	conf.
0284X.000	1/2"x3/4"	12,055	20

art. **288** 

Rubinetto a tre vie attacco lavatrice.



00288.002	1/2"x 1/2"x 3/4"	15,749	20
-----------	------------------	--------	----

art. **288X**

Rubinetto a tre vie attacco lavatrice



0288X.000	1/2"x 1/2"x 3/4"	10,400	20
-----------	------------------	--------	----

art. **298** 

Rubinetto inclinato attacco lavatrice.



00298.000	1/2"x3/4"	13,227	10
-----------	-----------	--------	----

art. **1480**

Rubinetto ad angolo orizzontale pesante, maniglia in ottone.

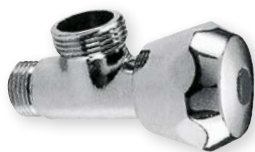

01480.002	1/2"x3/4"	20,378	10
-----------	-----------	--------	----

art. **517ML**

Rubinetto salvaspazio attacco lavatrice maniglia in ottone cromato.



517ML.MIN	1/2"x3/4"	18,675	10
-----------	-----------	--------	----

**art. 1482**

Crociera per gruppo dado girevole con distanziale in ottone.

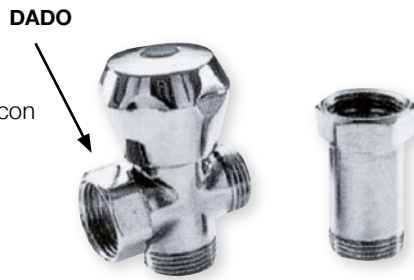

cod. art.	mis.	€	conf.
01482.000	3/4"	19,275	10

**art. 1483**

Crociera per gruppo con distanziale in ottone dado fisso.



01483.000	3/4"	16,896	20
-----------	------	--------	----

**art. 286**

Distanziale in ottone cromato con foro 3/8".



00286.000	3/4"	8,270	10
00287.000	3/4"	7,603	10

**art. 287**

Distanziale in ottone cromato senza foro.

**art. 1484**

Distanziale retrogruppi con dado girevole da Ø 3/4", con foro 3/8".



01484.000		13,686	10
01485.000		15,207	10

**art. 1485**

Distanziale retrogruppi con dado girevole da Ø 3/4", senza foro.

**art. 1484B**

Coppia distanziabile retrogruppo con dado girevole da Ø 3/4", con foro da 1/2" e senza foro.

1484B.000	3/4"x1/2"	26,678	10
-----------	-----------	--------	----

**art. 517**

Rubinetto ottone cromato a sfera per attacco lavatrice a squadra pesante con maniglia ABS.

**MADE IN ITALY**



00517.000	1/2"x3/4"	9,504	10
-----------	-----------	-------	----

**art. 517X**

Rubinetto ottone cromato a sfera per attacco lavatrice a squadra con maniglia ABS.

**IMPORT**

0517X.000	1/2"x3/4"	7,837	10
-----------	-----------	-------	----

art. **517PE**

Rubinetto ottone cromato a sfera per attacco lavatrice a squadra pesante con maniglia in metallo.  
**MADE IN ITALY**



cod. art.	mis.	€	conf.
<b>517PE.MET</b>	1/2" x 3/4"	<b>15,273</b>	40

art. **517LX**

Rubinetto ottone cromato a sfera mod. Lux per attacco lavatrice maniglia metallo.



<b>517LX.000</b>	1/2"x3/4"	<b>12,005</b>	10
------------------	-----------	---------------	----



art. **517VL**

Rubinetto lavatrice a sfera modello "Locom"



<b>517VL.000</b>	1/2x3/4	<b>16,432</b>	10
------------------	---------	---------------	----

11



art. **517VX**

Rubinetto lavatrice a sfera, maniglia ottone modello "Squalo"



<b>517VX.000</b>	1/2x3/4	<b>31,410</b>	10
------------------	---------	---------------	----



art. **549VA**

Valvola antiaggimento, nylon, attacchi da 3/4" maschio-femmina.



<b>549VA.000</b>	3/4x3/4	<b>32,097</b>	10
------------------	---------	---------------	----

art. **517NL**

Rubinetto lavatrice a sfera modello "Linea", rosone ottone, cromato



<b>517NL.000</b>	1/2x3/4	<b>43,019</b>	10
------------------	---------	---------------	----

**art. 289** 

Rubinetto doppio con due uscite  
attacco lavatrice e lavastoviglie.



cod. art.	mis.	€	conf.
00289.000	1/2"	28,763	6

**art. 290** 

Rubinetto duplex pesante in ottone cro-  
mato.



00290.002	1/2"x3/4"	30,576	10
-----------	-----------	--------	----

**art. 290X**

Rubinetto biuso attacco lavatrice  
**IMPORT**



00290X.000	1/2"x3/4"	20,843	12
------------	-----------	--------	----

**art. 291**

Rubinetto a snodo attacco lavatrice.



00291.002	1/2"x3/4"	49,538	10
-----------	-----------	--------	----

**art. 292**

Rubinetto a snodo canna sotto.



00292.002	1/2"	37,421	10
-----------	------	--------	----

**art. 293**

Rubinetto a snodo canna sopra.



00293.002	1/2"	39,205	10
-----------	------	--------	----

**art. 1025**

Rubinetto a snodo pesante, canna  
c/rompigetto, Ø 3/8" - 1/2".



01025.002	1/2"	45,245	4
1025U.002	1/2"	34,986	4

**art. 1025U**

Idem canna sopra.

**art. 294**

Gruppo lavello con rompigetto canna  
sotto interasse cm 16. **MADE IN ITALY**

**art. 294 C**

Canna ricambio

**art. 294V**

Vitone ricambio.



00294.000		81,744	1
0294C.CAN		19,478	1
0294V.VIT		8,024	1

### art. 1673

Il gruppo lavello universale è stato concepito per rendere vita facile all'operatore che potrà sostituire il vecchio gruppo lavello in modo facile, pratico e economico senza rimuovere gli eccentrici dal muro. È composto da due parti telescopiche allungabili fino a raggiungere l'esatto interasse da un minimo di 130mm ad un massimo di 180mm.

**MADE IN ITALY**

### art. 1673.PLA

Placchetta ricambio

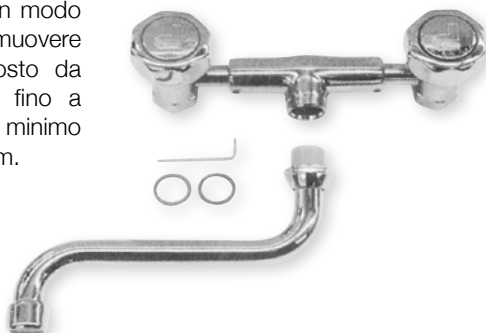

cod. art.	mis.	€	conf.
01673.000		145,898	4
01673.PLA		5,280	4

### art. 295

Gruppo lavello con rompigitto canna sopra. Interasse cm 16

**MADE IN ITALY**



00295.000		81,077	1
-----------	--	--------	---

### art. 296

Gruppo lavello con rompigitto, attacco lavatrice canna sotto.

Interasse cm 16

**MADE IN ITALY**



00296.000		122,837	1
-----------	--	---------	---

### art. 297

Gruppo lavello con rompigitto, attacco lavatrice canna sopra.

Interasse cm 16

**MADE IN ITALY**



00297.000		122,837	1
-----------	--	---------	---

### art. 593

Gruppo miscelatore scaldabagno, canna snodata senza tubetti, tipo pesante.



00593.002	1/2"	74,762	2
-----------	------	--------	---

### art. 299

Rubinetto inclinato passo rapido.



00299.002	1/2"	23,388	10
-----------	------	--------	----

### art. 300

Rubinetto inclinato passo rapido con portagomma.



00300.002	1/2"	26,612	10
-----------	------	--------	----



**art. 301**

Rubinetto a squadra passo rapido.



cod. art.	mis.	€	conf.
00301.000	1/2"	<b>23,762</b>	10

**art. 302**

Rubinetto a squadra passo rapido con portagomma.



00302.000	1/2"	<b>28,702</b>	10
-----------	------	---------------	----

**art. 303**

Rubinetto prolungato Trieste cromato.



00303.000	1/2"	<b>31,743</b>	10
-----------	------	---------------	----

**art. 303P**

Rubinetto prolungato Trieste cromato con rompighetto.



0303P.000	1/2"	<b>38,123</b>	10
-----------	------	---------------	----

**art. 304**

Rubinetto cromato con portagomma.



00304.000	1/2"	<b>30,356</b>	10
-----------	------	---------------	----

**art. 305**

Rubinetto curvo giallo.



00305.002	1/2"	<b>16,727</b>	10
-----------	------	---------------	----

**art. 259IN**

Raccordo portagomma a innesto rapido in ottone giallo.



259IN.000	1/2"	<b>3,920</b>	10
259IN.001	3/4"	<b>4,310</b>	10

**Misura corrispondente al rubinetto**
**art. 260IN**

Raccordo portagomma a innesto rapido in ottone cromato.



260IN.000	1/2"	<b>4,705</b>	10
-----------	------	--------------	----

**Misura corrispondente al rubinetto**

### art. 260

Raccordo portagomma in ottone nichelato.  
 Temperature minima e massima d'esercizio:  
 -20°C, 80°C.  
 Attacco filettato ISO228  
 (equivalente a DIN EN ISO 228 e  
 BS EN ISO 228).



cod. art.	mis.	€	conf.
00260.002	3/4" x RUB 1/2"	<b>2,261</b>	100
00260.003	1" x RUB 3/4"	<b>3,875</b>	50
00260.004	1"1/4 x RUB 1"	<b>7,804</b>	25

### art. 260PY

Raccordo portagomma in nylon  
 Temperature minima e massima d'esercizio:  
 -20°C, 80°C.  
 Attacco filettato ISO228  
 (equivalente a DIN EN ISO 228 e  
 BS EN ISO 228).



<b>260PY.034</b>	3/4" x RUB 1/2"	<b>1,174</b>	150
<b>260PY.100</b>	1" x RUB 3/4"	<b>1,697</b>	75

### art. 260NY

Raccordo portagomma in nylon orientabile  
 a 360°. Temperatura minima e massima  
 d'esercizio: -20°C, 80°C.  
 Attacchi filettati: ISO228  
 (equivalente a DIN EN ISO 228 e BS EN  
 ISO 228).



<b>260NY.034</b>	3/4" x RUB 1/2"	<b>1,875</b>	50
------------------	-----------------	--------------	----

11

### art. 311-IT

Rubinetto portagomma a sfera GAR  
 Con maniglia a leva



		bar/psi	
<b>311IT.012</b>	1/2"(DN 15)	15/217.5	<b>12,614</b> 15
<b>311IT.034</b>	3/4"(DN 20)	15/217.5	<b>16,862</b> 10

### art. 521-IT

Rubinetto portagomma a sfera GAR  
 Con maniglia a farfalla



		bar/psi	
<b>521IT.012</b>	1/2"(DN 15)	15/217.5	<b>12,651</b> 15
<b>521IT.034</b>	3/4"(DN 20)	15/217.5	<b>16,678</b> 10

### art. 311LU

Rubinetto portagomma a sfera con porta-  
 lucchetto  
 Corpo in ottone nichelato.  
 Raccordo in ottone.  
 Maniglia a leva in acciaio.  
 Temperatura minima e massima  
 d'esercizio: 0°C, 80°C.  
 Attacco filettato ISO228  
 (equivalente a DIN EN ISO 228  
 e BS EN ISO 228).  
 Misure disponibili:  
 1/2"x3/4", 3/4"x3/4".



		bar/psi	
<b>311LU.000</b>	1/2"(DN 15)	15/217.5	<b>24,565</b> 8

**art. 624IT** 

Rubinetto a sfera SPIN  
con portagomma orientabile  
Resistente al gelo.



cod. art.	mis.	€	conf.
<b>624IT.012</b>	1/2"	<b>15,961</b>	8
<b>624IT.034</b>	3/4"	<b>23,994</b>	8

**art. 8647**

Rubinetto di erogazione a sfera  
con portagomma INOX AISI 316  
Leva: Acciò Inox AISI 304



<b>08647.000</b>	Ø 1/2"	<b>42,519</b>	10
------------------	--------	---------------	----

**art. 311E**

Rubinetto con portagomma a sfera sabbato  
sbiancato. Con maniglia a leva.  
**IMPORT**



<b>0311E.001</b>	1/2"	<b>8,754</b>	10
<b>0311E.002</b>	3/4"	<b>12,005</b>	10

**art. 311**

Rubinetto con portagomma a sfera  
sabbato sbiancato. Con maniglia a leva.  
**MADE IN ITALY**



<b>00311.001</b>	3/8"	<b>16,128</b>	10
<b>00311.002</b>	1/2"	<b>13,298</b>	10
<b>00311.003</b>	3/4"	<b>22,556</b>	6
<b>00311.004</b>	1"	<b>30,451</b>	4

**art. 311PE FIV** 

Rubinetto portagomma a sfera  
sbiancato PESANTE con portagomma.



<b>311PE.012</b>	1/2"	<b>18,371</b>	10
<b>311PE.034</b>	3/4"	<b>22,289</b>	6
<b>311PE.100</b>	1"	<b>36,454</b>	4

**art. 311DX**

Rubinetto Duplex a sfera sbiancato  
con portagomma.



<b>311DX.000</b>	1/2 x 3/4	<b>24,863</b>	8
------------------	-----------	---------------	---

### art. 1050

Rubinetto portagomma EUROGARDEN, maniglia a farfalla, colori a scelta.  
Innovativo: il corpo di Eurogarden, in resina termoplastica (Hostaform C 9021 - GV 1/30), è ottenuto da stampaggio in un unico pezzo in modo da offrire le migliori caratteristiche meccaniche.  
Robusto: Eurogarden resiste a temperature molto basse. Il vitone e il portagomma sono in ottone, il corpo in resina termoplastica evita il formarsi di incrostazioni.  
Colorato: Eurogarden è prodotto in una vasta gamma di colori che lo rendono gradevole e simpatico.  
Economico: il rapporto prezzo-qualità di Eurogarden non ha confronti.

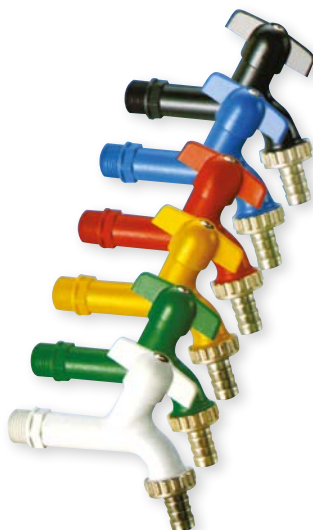

cod. art.	mis.	€	conf.
01050.NER	1/2"	14,984	15
01050.BLU	1/2"	14,984	15
01050.ROS	1/2"	14,984	15
01050.GIA	1/2"	14,984	15
01050.VER	1/2"	14,984	15
01050.BIA	1/2"	14,984	15

### art. 307PR

Rubinetto portagomma passo rapido giallo.



307PR.000	1/2"	25,967	10
-----------	------	--------	----

### art. 308PR

Rubinetto portagomma passo rapido cromato.



308PR.000	1/2"	28,595	10
-----------	------	--------	----

### art. 312

Idrante a squadra.



00312.001	1/2"	16,889	10
-----------	------	--------	----

### art. 314

Idrante a sfera, maniglia a farfalla.



00314.001	1/2"	30,568	10
00314.002	3/4"	38,646	10
00314.003	1"	58,951	6

**art. 307**

Rubinetto curvo con portagomma giallo.

**art. 308**

Rubinetto curvo con portagomma sabbato cromato.

**art. 309**

Rubinetto portagomma pesante giallo.

**art. 309A**

Rubinetto portagomma giallo.

**art. 309IN**

Rubinetto portagomma pesante ottone giallo con raccordo innesto rapido

**art. 309X**

 Rubinetto in ottone giallo lucido con portagomma  
**IMPORT**

**art. 310**

Rubinetto curvo giallo con portagomma con chiave estraibile.

**art. 310A**

Solo chiavetta.

**art. 7899**

Rubinetto a sfera a squadra per olio con levetta nera.

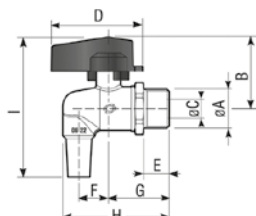

cod. art.	mis.	€	conf.
-----------	------	---	-------

00307.001	3/8"	16,140	10
00307.002	1/2"	21,298	10
00307.003	3/4"	24,455	6
00307.004	1"	33,015	4
00308.002	1/2"	19,426	10

00309.000	1/2"	24,331	10
0309A.000	1/2"	20,529	12

309IN.000	1/2"	28,515	10
-----------	------	--------	----

0309X.000	1/2"	17,163	10
-----------	------	--------	----

00310.002	1/2"	23,188	10
00310.003	3/4"	31,747	10
00310.004	1"	34,237	10
0310A.000		1,806	10

07899.012	1/2"	12,547	12
-----------	------	--------	----

art. **512**

Rubinetto a pulsante frontale. Giallo lucido.



cod. art.	mis.	€	conf.
00512.000	1/2"	<b>38,254</b>	1

art. **512P**

Rubinetto pesante a pulsante frontale  
ottone giallo



0512P.000	1/2"	<b>50,806</b>	1
-----------	------	---------------	---



art. **1704**

Rubinetto artistico a vitone con rosone e portagomma.



01704.000	1/2"	<b>48,113</b>	1
-----------	------	---------------	---

art. **1705**

Rubinetto tipo "IMPERO" vitone tradizionale,  
completo di rosone e rompigitto.



01705.GIA	1/2"	<b>59,047</b>	1
01705.BRO	1/2"	<b>71,019</b>	1

art. **1708**

Rubinetto artistico "IMPERO" con rosone e portagomma.



01708.000	1/2"	<b>48,113</b>	1
-----------	------	---------------	---

art. **1709**

Rubinetto tipo "IMPERO" vitone rapido,  
completo di rosone e rompigitto.  
Trattato giallo, bronzo.



01709.GIA	1/2"	<b>58,213</b>	1
01709.BRO	1/2"	<b>69,026</b>	1



**art. 1710**

Bocca tipo "CHIMERA".



cod. art.	mis.	€	conf.
01710.002	3/4"	124,242	1

**art. 1712**

Testa di leone completa di erogatore continuo



01712.000	1/2"	82,828	1
-----------	------	--------	---

**art. 1716**

Maschera rinascimentale con erogatore continuo attacco 1/2" F.



01716.000	1/2"	77,672	1
-----------	------	--------	---

**art. 1722**

Rubinetto artistico erogazione continua.



01722.000	3/4"	85,325	1
-----------	------	--------	---

**art. 1714A / 1714B**

Rosoni con foro per rubinetti da 1/2".



1714A.000		9,834	10
1714B.000		14,111	10

**art. 1715**

Riduzione per attacco portagomma per ns articoli 1704 - 1708



01715.000	3/4"	6,203	10
-----------	------	-------	----

**art. 1715A**

Rompigetto per ns articoli 1704 - 1708



1715A.000	1/2"	6,203	10
-----------	------	-------	----

### art. 513

Rubinetto a pulsante frontale regolabile da 0 a 40 secondi circa. Cromato.



cod. art.	mis.	€	conf.
00513.000	1/2"	66,279	2

### art. 513E

Rubinetto temporizzato a parete in ottone cromato.



0513E.000	1/2"	87,149	2
-----------	------	--------	---

#### Caratteristiche tecniche:

Azionamento: a pulsante  
 Tempo di apertura: 6/10 sec  
 Pressione min. di esercizio: 0,5 bar  
 Pressione max. di esercizio: 6 bar  
 Temp. min. di esercizio: 5°C  
 Temp. max. di esercizio: 70°C.

### art. 1042

Rubinetto collo cigno a pulsante temporizzato regolabile da 0 a 40 secondi circa. Cromato.



01042.000		100,044	2
01042.R01	vitone	43,144	2

11

### art. 1044

Rubinetto miscelatore collo cigno temporizzato cromato.



01044.000		212,760	1
-----------	--	---------	---

### art. 661SN

Rubinetto frontale temporizzato, con canna "S", 1/2", in ottone cromato.



661SN.000	1/2"	80,702	1
-----------	------	--------	---

### art. 1054

Beverino c/rubinetto a pulsante a chiusura istantanea. Portata regolabile.

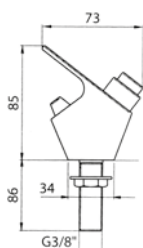

01054.000		110,882	1
-----------	--	---------	---

**art. 581**

Rubinetto a muro, comando a gomito, canna girevole.



cod. art.	mis.	€	conf.
00581.000	1/2"	<b>66,363</b>	2
00581.R01	vitone	<b>10,004</b>	1

**art. 582**

Rubinetto a muro, comando a gomito.



00582.000	1/2"	<b>59,693</b>	2
-----------	------	---------------	---

**art. 583**

Rubinetto collo cigno, comando a gomito.



00583.000		<b>77,534</b>	2
-----------	--	---------------	---

**art. 584**

Colonnina Bar, comando a gomito.



00584.000		<b>157,569</b>	1
-----------	--	----------------	---

art. **596**

Miscelatore monocomando per lavabo con leva a gomito.



cod. art.	mis.	€	conf.
00596.000		128,946	1

art. **597**

Miscelatore monocomando monoforo per lavello con leva a gomito.



00597.000		133,392	1
-----------	--	---------	---

art. **598**

Miscelatore monocomando a muro per lavello con leva a gomito.

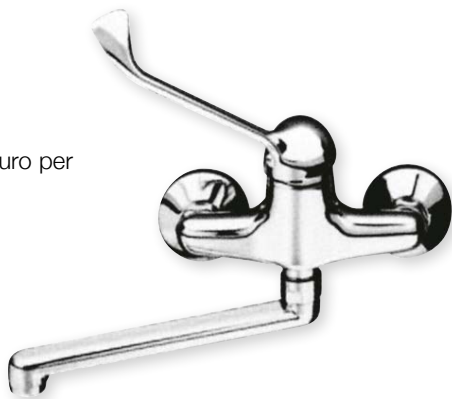

00598.000		155,624	1
-----------	--	---------	---

art. **5624**

Leva clinica in ottone cromato per monocomando miscelatori.



05624.00	x Ø40 cartuccia	18,198	5
05624.001	x Ø35 cartuccia	19,759	5

art. **955**

Rubinetto monolavello.



00955.002	1/2"	50,689	2
-----------	------	--------	---

**art. 557**

Rubinetto temporizzato a pulsante per doccia esterno.



cod. art.	mis.	€	conf.
00557.000		102,045	1

**art. 555**

Rubinetto temporizzato a pulsante per doccia incasso.

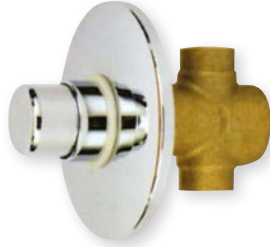

00555.000		102,045	1
-----------	--	---------	---

**art. 558**

Miscelatore incasso temporizzato per doccia. (Apertura: 15/25 sec.).

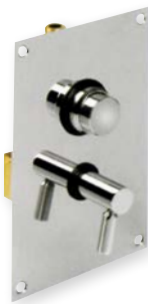
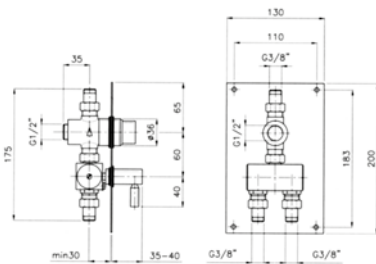

00558.000		217,596	1
-----------	--	---------	---

**art. 570**

Miscelatore termostatico sottoboiler per l'installazione sotto tutti i tipi di scaldabagno con raccordi regolabili da 45x120 mm.



00570.000		178,954	1
-----------	--	---------	---

**art. 571**

Gruppo di premiscelazione meccanico completo di valvole di non ritorno. È possibile montare direttamente il gruppo di premiscelazione 571 sotto ai rubinetti.



00571.000	1/2"	86,771	1
-----------	------	--------	---

art. 572 

MINICASTOR miscelatore termostatico ø 3/4" legge n. 10/91 - risparmio di energia - D.P.R. n. 412/93 - ideale per abitazioni e piccoli impianti.

Portata in lt./minuto MINICASTOR							
bar	1	1,5	2	2,5	3	4	5
L/min.	20	26	30	34	38	45	50



cod. art.	mis.	€	conf.
00572.000	3/4"	280,107	1

art. 573 

**MISCELATORE TERMOSTATICO ECOSAN PER COMUNITÀ.**

Per la gestione dell'acqua calda con produzione centralizzata. Tutta la serie è dotata di termostato ad espansione di liquido. È anticalcare. La cartuccia termostatica è facilmente estraibile e sostituibile. Legge 10/91 DPR 412193.

**SCELTA DEL MISCELATORE**

Per calcolare il diametro del miscelatore da utilizzare si deve considerare una portata media per apparecchio di 10 litri/minuto, quindi per ottenere il totale dei litri è sufficiente moltiplicare il numero degli apparecchi per 10 e scegliere in base alla pressione il ø del miscelatore.

Bar	Portata in lt./minuto			
	1"	1 1/4"	1 1/2"	2"
1	53	82	155	312
2	75	118	225	300
3	92	145	270	370
4	108	167	320	430

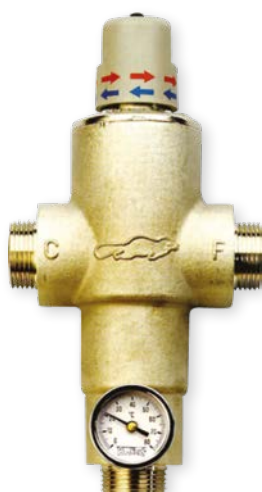

00573.001	1"	720,375	1
00573.002	1 1/4"	740,021	1
00573.003	1 1/2"	1179,239	1
00573.004	2"	1272,697	1

art. 574 

**SISTEMA TERMOSTATICO ECOSYSTEM**

Legge 10/91 D.P.R. 412/93.

Per impianti di distribuzione acqua sanitaria con anello di ricircolo.

Per limitare la temperatura di distribuzione a 48° e per evitare erogazioni a temperatura superiori.

00574.001	1"	1092,210	1
00574.002	1 1/4"	1146,921	1
00574.003	1 1/2"	1799,679	1
00574.004	2"	1893,995	1





**art. 1028** 
**RUBINETTI PROFESSIONALI A PEDALE CON DISPOSITIVO DI FERMO**

Appositamente studiati per grandi cucine - supermercati - negozi alimentari.

Togliendo il piede la leva di comando blu resta abbassata e continua l'erogazione.

Per chiudere l'acqua premere la leva gialla, la leva di comando tornerà automaticamente nella posizione iniziale.

cod. art.	mis.	€	conf.
01028.000	<b>A</b> 345 mm <b>B</b> 170 mm	<b>310,384</b>	1

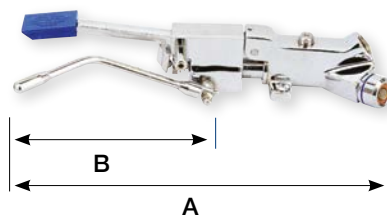

**art. 1029** 
**MISCELATORI PROFESSIONALI A PEDALE CON DISPOSITIVO DI FERMO**

La regolazione della corsa della leva di comando rossa è millimetrica quindi premendo è possibile ottenere acqua fredda, acqua miscelata e progressivamente acqua calda.

Togliendo il piede la leva di comando resta nella posizione desiderata e continua l'erogazione. La leva gialla serve per la chiusura automatica.

E' incorporato in entrambi i modelli il regolatore di portata e il dispositivo anti colpo d'ariete ( brevettato ).

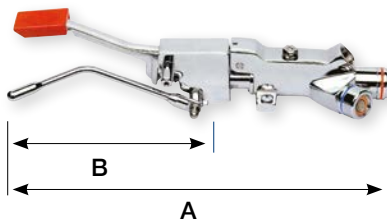
01029.000	<b>A</b> 365 mm <b>B</b> 170 mm	<b>368,276</b>	1
-----------	------------------------------------	----------------	---

**art. 1030** 

Rubinetto a pedale esterno, per fissaggio a pavimento con cartuccia interamente in ottone e con dispositivo anti colpo d'ariete. Regolatore di portata in uscita e filtro inox in entrata acqua fredda con indicatore blu per il montaggio.

01030.000	<b>A</b> 275 mm <b>B</b> 150 mm	<b>189,916</b>	1
-----------	------------------------------------	----------------	---

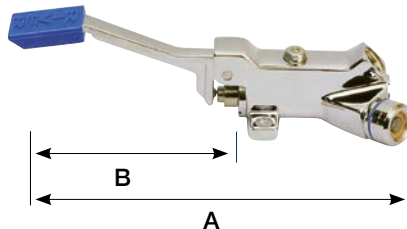
**art. 1031** 

Miscelatore a pedale esterno, per fissaggio a pavimento con cartuccia per la miscelazione progressiva interamente in ottone e con dispositivo anti colpo d'ariete. Regolatore di portata in uscita e filtri inox in entrata acqua fredda e calda con indicatori blu e rosso per il montaggio. La corsa del pedale è limitata da un dispositivo per evitare bruciature e conforme alla legge n. 10/91

01031.000	<b>A</b> 300 mm <b>B</b> 150 mm	<b>253,422</b>	1
-----------	------------------------------------	----------------	---

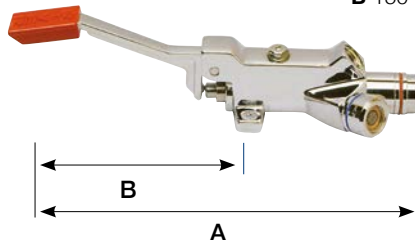
**art. 1035** 

Rubinetto a pedale esterno, per fissaggio a parete con cartuccia interamente in ottone e con dispositivo anti colpo d'ariete. Regolatore di portata in uscita e filtro inox in entrata acqua fredda con indicatore blu per il montaggio. In dotazione dima di montaggio.

01035.000	<b>A</b> 280 mm <b>B</b> 240 mm	<b>219,193</b>	1
-----------	------------------------------------	----------------	---

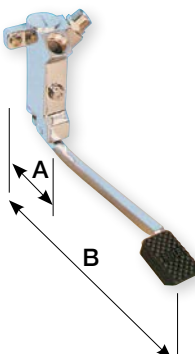

art. **1036** 

Miscelatore a pedale esterno, per fissaggio a parete con cartuccia per la miscelazione progressiva interamente in ottone e con dispositivo anti colpo d'ariete. Regolatore di portata in uscita e filtri inox in entrata acqua fredda e calda con indicatori blu e rosso per il montaggio. La corsa del pedale è limitata da un dispositivo per evitare bruciature e conforme alla legge n. 10/91. In dotazione dima di montaggio.

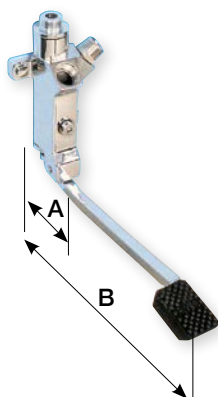

cod. art.	mis.	€	conf.
01036.000	A 280 mm B 240 mm	<b>277,742</b>	1

art. **1030A** 

**RUBINETTI PROFESSIONALI A PEDALE**  
Rubinetto a pedale esterno per il fissaggio a pavimento, con filtro a sacchetto in acciaio inox sull'entrata acqua fredda facilmente ispezionabile. Cartuccia completamente estraibile senza togliere il rubinetto dal pavimento, regolatore di portata incorporato.

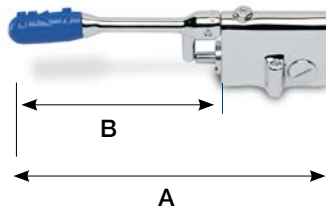

1030A.000	A 255 mm B 170 mm	<b>199,350</b>	1
-----------	----------------------	----------------	---

art. **1035A** 

**RUBINETTI PROFESSIONALI A PEDALE**  
Rubinetto a pedale esterno per il fissaggio a parete, con filtro a sacchetto in acciaio inox sull'entrata acqua fredda facilmente ispezionabile. Cartuccia completamente estraibile senza togliere il rubinetto dalla parete, regolatore di portata incorporato. In dotazione dima di montaggio.

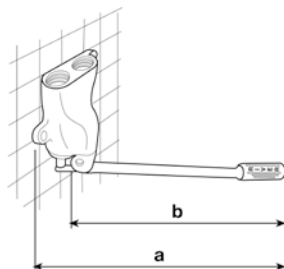

1035A.000	A 300 mm B 250 mm	<b>227,565</b>	1
-----------	----------------------	----------------	---

art. **1031A** 

**MISCELATORI PROFESSIONALI A PEDALE**

Miscelatore a pedale esterno per il fissaggio a pavimento, con filtri a sacchetto in acciaio inox sulle entrate acqua fredda e calda facilmente ispezionabile. Premendo la leva si ottiene acqua fredda, progressivamente miscelata e bollente. Cartuccia interamente in ottone con dispositivo anti colpo d'ariete, completamente estraibile senza togliere il miscelatore dal pavimento, regolatore di portata incorporato. Dispositivo per evitare le bruciature conforme alla legge n. 10/91.

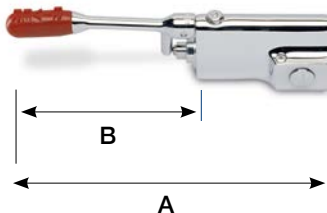

1031A.000	A 290 mm B 170 mm	<b>318,687</b>	1
-----------	----------------------	----------------	---

art. **1036A**   
**MISCELATORI PROFESSIONALI A PEDALE**

Miscelatore a pedale esterno per il fissaggio a parete, con filtri a sacchetto in acciaio inox sulle entrate acqua fredda e calda facilmente ispezionabile.  
 Premendo la leva si ottiene acqua fredda, progressivamente miscelata e bollente.  
 Cartuccia interamente in ottone con dispositivo anti colpo d'ariete, completamente estraibile senza togliere il miscelatore dalla parete, regolatore di portata incorporato.  
 Dispositivo per evitare le bruciature conforme alla legge 1091.

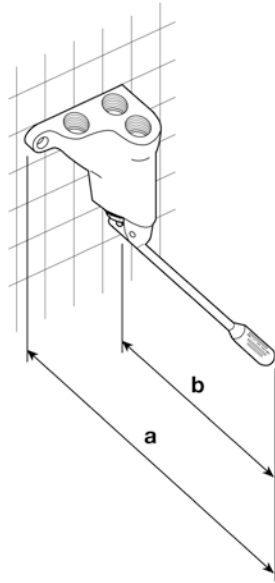

cod. art.	mis.	€	conf.
<b>1036A.000</b>	<b>A 300 mm</b> <b>B 250 mm</b>	<b>345,933</b>	<b>1</b>

art. **1032**   
 Rubinetto miscelatore a pavimento con comando 2 pedali.

La leva blu è per l'acqua solo fredda, la leva rossa è per acqua solo calda. L'acqua miscelata si ottiene premendo le due leve insieme.

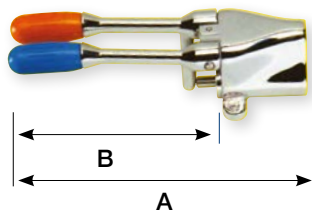

<b>01032.000</b>	<b>A 240 mm</b> <b>B 170 mm</b>	<b>244,225</b>	<b>1</b>
------------------	------------------------------------	----------------	----------

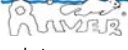
art. **1033**   
 Rubinetto miscelatore a parete con comando a 2 pedali. La leva blu è per l'acqua solo fredda, la leva rossa è per acqua solo calda. L'acqua miscelata si ottiene premendo le due leve insieme.

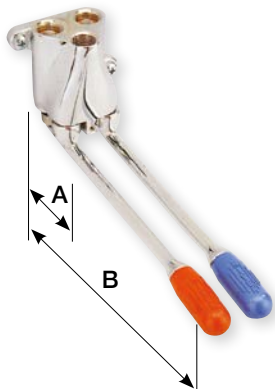

<b>01033.000</b>	<b>A 295 mm</b> <b>B 250 mm</b>	<b>305,630</b>	<b>1</b>
------------------	------------------------------------	----------------	----------

art. **1034**  
 Rubinetto a pedana con chiusura istantanea automatica per alimentare lavabi, docce, orinatoi - piastra inox regolabile e codoli per facilitare l'installazione - la pedana non permette infiltrazioni d' acqua nel pavimento e la sua sagomatura agevola l'apertura con carrozzina.



<b>01034.000</b>		<b>125,670</b>	<b>1</b>
------------------	--	----------------	----------

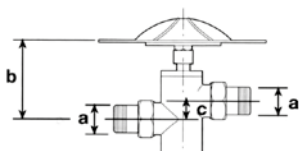

A	B	C
1/2" F	35	72

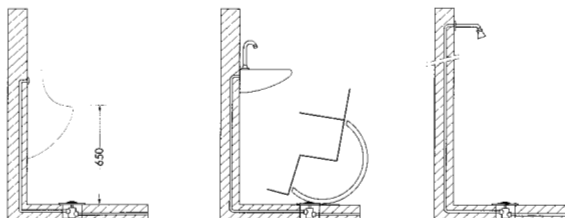

## art. 1027

Miscelatori a pedale per montaggio sospeso.  
Mod. GIRO

Brevettato - montaggio sospeso a mm.  
150 dal pavimento.

La leva di comando ruota a 360°. Il fissaggio del corpo del miscelatore è quindi indipendente dalla posizione della leva. Premendo il pedale si ottiene acqua fredda e progressivamente acqua miscelata e solo calda.

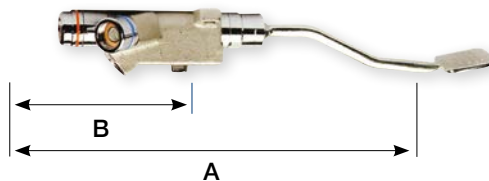

cod. art.	mis.	€	conf.
01027.000	A 390 mm B 215 mm	243,731	1

## art. 1037

Rubinetto - miscelatore pedaliera universale per installazione a pavimento o a parete.

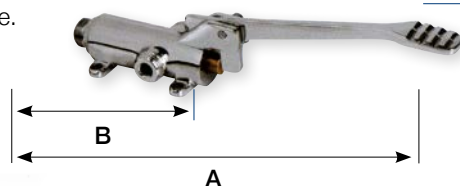
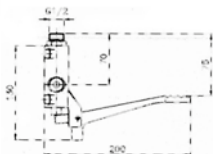
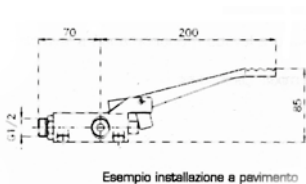

01037.000	A 270 mm B 160 mm	158,603	1
-----------	----------------------	---------	---

## art. 1038

Miscelatore monopedale progressivo in ottone cromato.

### Caratteristiche tecniche:

Tipo di installazione: parete/pavimento  
Pedale: metallo con gomma antiscivolo  
Ingresso acqua fredda: 1/2" M.  
Ingresso acqua calda: 1/2" M.  
Uscita erogazione: 1/2" M.  
Pressione max. di esercizio: 6 bar  
Temp. max. di esercizio: 70°C  
Valvole di non ritorno: in dotazione  
Viti di fissaggio in acciaio Ø10 mm: in dotazione.



01038.PRO	125,055	1
-----------	---------	---

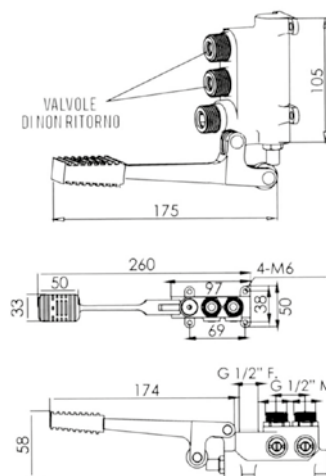

## art. 1812

Rubinetto lavabo monoforo con gruppo di miscelazione sotto lavabo e comando a fotocellula funzionante a corrente.

.bocca completa di fotocellula con scheda elettronica  
.trasformatore 220 / 6 Volt  
.elettrovalvola 3/8  
.gruppo di miscelazione sottolavabo



01812.000	525,856	1
01812.BAT	525,856	1

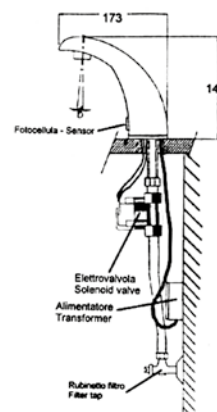

## art. 1812BAT

Rubinetto lavabo monoforo con gruppo di miscelazione sotto lavabo e comando a fotocellula funzionante a pile.

.bocca completa di fotocellula con scheda elettronica  
.scatola porta pile  
.elettrovalvola 3/8  
.pile al litio 6 Volt 13 mAh

**art. 1812E**

Miscelatore elettronico per lavabo in ottone cromato.

**Caratteristiche tecniche:**

Alimentazione: batterie alcaline 6V  
 Azionamento: a pulsante  
 Pressione min. di esercizio: 0,5 bar  
 Pressione max. di esercizio: 6 bar  
 Temp. min. di esercizio: 5°C  
 Temp. max. di esercizio: 70°C  
 Flessibili da 1/2" F: in dotazione  
 Valvole di non ritorno M. F. 1/2":  
 in dotazione.



cod. art.	mis.	€	conf.
<b>1812E.000</b>	1/2"	<b>313,471</b>	1

**art. 579**

Canna in ottone cromato a "S" per gruppo lavello universale.



00579.000	cm. 15	<b>8,893</b>	10
00579.001	cm. 20	<b>12,850</b>	10
00579.002	cm. 25	<b>13,495</b>	10
00579.003	cm. 30	<b>14,718</b>	10

**art. 579A**

Canna in ottone cromato a ponte per gruppo lavello universale.



0579A.001	cm. 20	<b>12,850</b>	10
0579A.002	cm. 25	<b>13,495</b>	10
0579A.003	cm. 30	<b>14,718</b>	10

**art. 579P**

Canna in ottone cromato universale a ombrella.



0579P.UNI	cm 185	<b>14,718</b>	5
-----------	--------	---------------	---

**art. 586**

Canna in ottone cromato per gruppo monoforo Yota universale.



00586.000	cm 20	<b>12,272</b>	10
-----------	-------	---------------	----

### art. 586P

Canna in ottone cromato per gruppo monoforo a tubo universale.

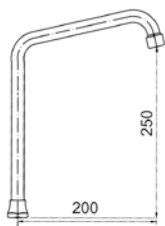

cod. art.	mis.	€	conf.
0586P.PON	20 x 25 cm	28,768	10

### art. 587A

Canna in ottone cromato a "S" telescopica regolabile per lavello attacco 3/4" con ghiera esagonale

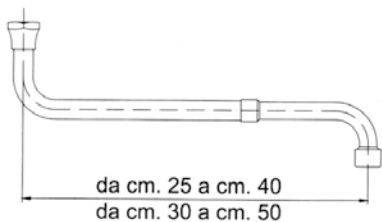

0587A.000	da cm 25 a cm 40	32,281	1
0587A.001	da cm 30 a cm 50	35,811	1

### art. 587P

Canna in ottone cromato universale a ponte per lavello attacco da 3/4" con ghiera esagonale

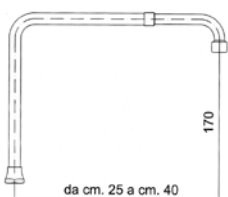

0587P.000	H 17 cm L da 25 a 40 cm	45,264	1
-----------	----------------------------	--------	---

### art. 2152

Bocca di erogazione vasca a parete con deviatore



02152.00	3/4"	97,960	1
----------	------	--------	---

### art. 2153

Bocca di erogazione vasca.



02153.00	3/4"	62,528	1
----------	------	--------	---

**art. 588**

Bocca in ottone cromato di erogazione a parete per rubinetto a pedale (sporgenza mm. 160).



cod. art.	mis.	€	conf.
00588.000		71,281	1

**art. 588A**

Bocca in ottone cromato di erogazione a parete per rubinetto a pedale.



0588A.000		45,003	1
-----------	--	--------	---

**art. 589**

Bocca in ottone cromato di erogazione girevole fusa con piantana. Per rubinetti a pedale.



00589.000		83,495	2
-----------	--	--------	---

**art. 589E**

Bocca di erogazione snodabile in ottone cromato.

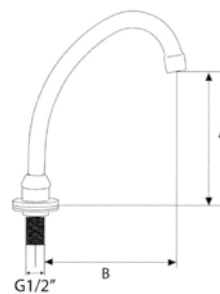

0589E.001	A120 - B130	39,870	1
0589E.002	A150 - B150	40,955	1
0589E.003	A165 - B170	42,023	1
0589E.004	A185 - B190	43,092	1

**art. 589X**

Bocca di erogazione snodabile in ottone cromato  
Pesante.



0589X.001	A155 - B130	48,485	1
0589X.002	A160 - B220	67,325	1

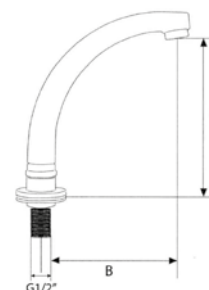



art. **589TU** 

Bocca in ottone cromato di erogazione orientabile per lavello. Con piantana.



cod. art.	mis.	€	conf.
<b>589TU.000</b>	165x200	<b>49,437</b>	1

art. **591E**

Bocca di erogazione fissa in ottone cromato.



<b>0591E.000</b>	A80 - B125	<b>64,629</b>	1
------------------	------------	---------------	---

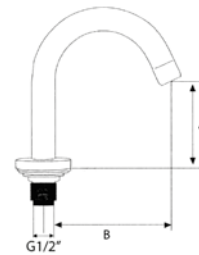

art. **591BX** 

Bocca di erogazione in ottone cromato fissa antivandalo. Con piantana.



<b>591BX.000</b>		<b>114,281</b>	1
------------------	--	----------------	---

art. **595** 

Bocca di erogazione in ottone cromato alta orientabile. Con piantana.

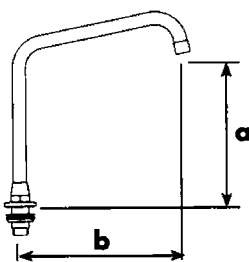

00595.001	260x250	<b>87,338</b>	1
00595.002	310x300	<b>98,150</b>	1

mm a	mm b
260	250
310	300

art. **590** 

Bocca erogazione in ottone cromato a muro fissa.



<b>00590.000</b>		<b>69,277</b>	1
------------------	--	---------------	---

art. **590E**

Bocca di erogazione a parete in ottone cromato.



<b>0590E.001</b>	A65 - B90	<b>46,538</b>	2
<b>0590E.002</b>	A65 - B140	<b>48,485</b>	2
<b>0590E.003</b>	A65 - B190	<b>51,707</b>	2

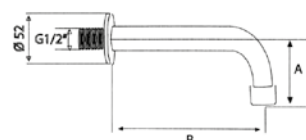

**art. 591** 

Bocca erogazione in ottone cromato fissa per lavabo.



cod. art.	mis.	€	conf.
00591.000		67,821	1

**art. 1040** 

Bocca erogazione in ottone cromato a parete orientabile a S.



01040.000		56,425	1
-----------	--	--------	---

**art. 1041** 

Bocca erogazione in ottone cromato a parete orientabile a U.



01041.000		56,425	1
-----------	--	--------	---

**art. 1840** 

Il costo di questi speciali raccordi è molto modesto. Il loro utilizzo è indispensabile in comunità, campings, centri sportivi, alberghi ecc. E' semplice fare un calcolo dell'enorme risparmio. N° 10 docce per circa 16 litri/minuto = 160 litri/minuto di acqua calda.

Con il riduttore di portata di 7 litri/minuto (più che sufficiente per una buona doccia) il consumo sarà soltanto di 70 litri.

Il risparmio in un anno di acqua e energia è superiore al 50%. Indipendentemente dalla pressione da 0,5 a 9 atm garantiscono:

- il consumo fisso di 7 litri/minuto
- l'impianto perfettamente bilanciato evitando, come solitamente avviene, che gli ultimi apparecchi scarseggino d' acqua
- acqua calda per tutti, riducendone il consumo aumentano la capacità della caldaia

I raccordi sono divisibili per l'eventuale pulizia del dispositivo di taratura. La membrana del dispositivo che con il suo movimento determina con precisione la quantità d' acqua in uscita è insensibile al calcareo.

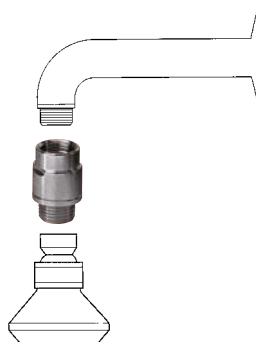

01840.000		23,687	6
-----------	--	--------	---

**Soprattutto quando è calda l'acqua ha un costo altissimo, perché spreccarla?**

