

SIFONI LINEA ABS CROMATI

art. 876

Sifone "bottiglia" cromato con attacco per orinatoio in ABS + ottone.



cod. art.	mis.	€	conf.
00876.000	1"1/4	52,626	6

art. 1227

Sifone "Esse" cromato, senza piletta, in ABS + ottone, con attacco piletta da 1" 1/4 e scarico Ø 32 x 250 mm.



01227.000	1"1/4	25,580	6
-----------	-------	--------	---

art. 1227E

Sifone "Esse" in ABS cromato.
Con attacco 1/4" uscita Ø32

1227E.000	1"1/4	22,678	6
-----------	-------	--------	---

art. 1228

Sifone "Kappa" cromato, senza piletta, in ABS + ottone, attacco piletta 1" 1/4 e scarico Ø32 x 250 mm.



01228.000	1"1/4	25,580	6
-----------	-------	--------	---

art. 1228E

Sifone "Kappa" in ABS cromato.
Uscita Ø32

1228E.000	1"1/4	22,678	6
-----------	-------	--------	---

art. 1229

Sifone bottiglia in ABS cromato
Attacco piletta da 1" 1/4 scarico Ø 32 x 250 mm.



01229.000	1"1/4	26,543	6
-----------	-------	--------	---

art. 1229E

Sifone bottiglia in ABS cromato.
Uscita Ø32

1229E.000	1"1/4	22,678	6
-----------	-------	--------	---

art. 351

Sifone a bottiglia in **ottone cromato** senza piletta, canna cm.20

art. 351CL

Sifone a bottiglia in **ottone cromato** senza piletta, canna cm.25

art. 353

Sifone a bottiglia in **ottone cromato** senza piletta, canna cm. 20.

art. 353CL

Sifone a bottiglia in **ottone cromato** senza piletta, canna cm. 25.



cod. art.	mis.	€	conf.
00351.000	1" cm. 20	23,976	30
351CL.000	1" cm. 25	24,258	30
00353.000	1"1/4 cm. 20	26,595	30
353CL.000	1"1/4 cm. 25	27,159	30

art. 356

Sifone a S in **ottone cromato** per bidet senza piletta, canna cm. 20

art. 356CL

Sifone a S in **ottone cromato** per bidet senza piletta, canna cm. 25.



00356.001	1" cm. 20	23,976	30
00356.002	1"1/4 cm. 20	26,595	30
356CL.001	1" cm. 25	24,258	30
356CL.002	1"1/4 cm. 25	27,159	30

art. 357

Sifone in **ottone cromato** ribassato senza piletta, canna cm. 25.

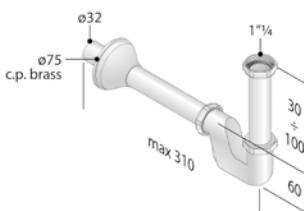

00357.002	1"1/4 x 25 cm	48,355	5
-----------	---------------	---------------	---

art. 358

Sifone a colonna in **ottone cromato** per lavabo senza piletta, canna cm. 20.

art. 358CL

Sifone a colonna in **ottone cromato** per lavabo senza piletta, canna cm. 25.



00358.001	1" cm.20	23,976	30
00358.002	1"1/4 cm 20	26,595	30
358CL.001	1" cm 25	24,258	30
358CL.002	1"1/4 cm 25	27,159	30

art. **353CE**

Sifone a bottiglia in **metallo cromato**
senza piletta, canna cm. 25 in acciaio inox
rosone in acciaio inox.

IMPORT

cod. art.	mis.	€	conf.
-----------	------	---	-------

353CE.114	1"1/4 cm. 25	22,678	10
------------------	--------------	---------------	----



art. **356CE**

Sifone a "S" bidet in **metallo cromato**
senza piletta, canna cm. 25 in acciaio inox
rosone in acciaio inox.

IMPORT

356CE.114	1"1/4 cm. 25	22,678	10
------------------	--------------	---------------	----



art. **358CE**

Sifone a "U" lavabo in **metallo cromato**
senza piletta, canna cm. 25 in acciaio inox
rosone in acciaio inox.

IMPORT

358CE.114	1"1/4 cm. 25	22,678	10
------------------	--------------	---------------	----



art. 1652

 Valvola di areazione per bagno e cucina
 MINI-VENT

cod. art.	mis.	€	conf.
01652.000		82,536	1

art. 1653

Raccordo a T per allaccio MINI-VENT

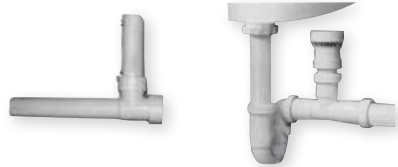

01653.000		15,007	1
-----------	--	--------	---

art. 1873 XLIRA

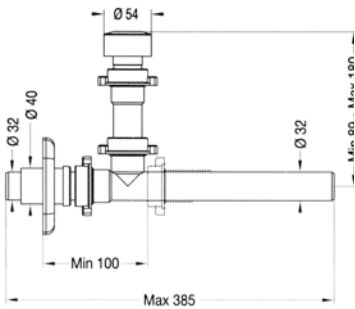
 Valvola automatica antigorgoglio da applicare all'uscita del sifone per lavabo e bidet
 "LIRA"
 Ø 32 Att. 1"1/4

01873.000	Ø32 -1"1/4	59,009	1
-----------	------------	--------	---

art. 1692

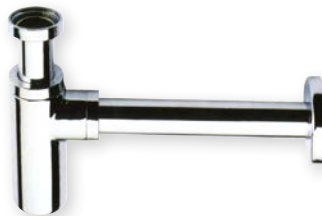
 Sifone lavabo a vista ottone cromato dadi
 lisci uscita Ø 32.

01692.000	1" 1/4	60,846	10
-----------	--------	--------	----

art. 1692B

 Sifone bidet a vista in ottone cromato -
 uscita Ø 32

1692B.000	1"1/4	50,772	10
-----------	-------	--------	----

art. 1693Q

 Sifone lavabo a vista Minimal quadro
 in ottone cromato.

1693Q.000	1"1/4	66,125	10
-----------	-------	--------	----

art. **1694N**

Sifone d'arredo tondo in ottone
Finitura nero opaco.



cod. art.	mis.	€	conf.
1694N.000	1"1/4x32x30 cm	72,949	6

art. **1694Q**

Sifone d'arredo quadrato in ottone
Finitura nero opaco.



1694Q.000	1"1/4x32x30 cm	114,634	1
------------------	----------------	----------------	---

art. **1694B**

Sifone d'arredo tondo in ottone
Finitura bianca opaca.

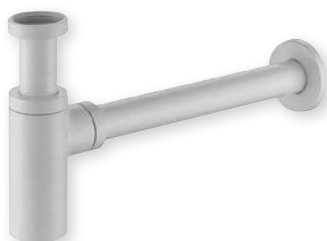

1694B.BIA	1"1/4x32x30 cm	72,949	1
------------------	----------------	---------------	---

art. **1694A**

Sifone d'arredo tondo in ottone
Finitura acciaio spazzolato.



1694A.ACC	1"1/4x32x30 cm	83,403	1
------------------	----------------	---------------	---

art. **1694Z**

Sifone d'arredo tondo in ottone
Finitura Bronzo.

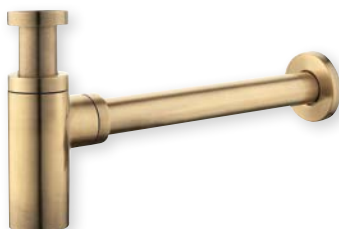

1694Z.BRO	1"1/4x32x30 cm	83,403	1
------------------	----------------	---------------	---

art. 7100

Sifone a S per lavabo in pp. bianco.



cod. art.	mis.	€	conf.
07100.000	1"1/4x40	9,218	30

art. 7102

Sifone a S per bidet in pp. bianco.

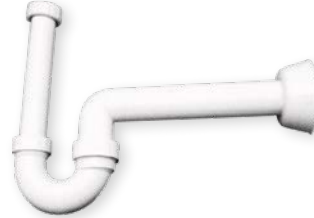

07102.000	1"1/4x40	9,218	30
-----------	----------	-------	----

art. 7104

Sifone ribassato per lavabo/bidet in pp. bianco.

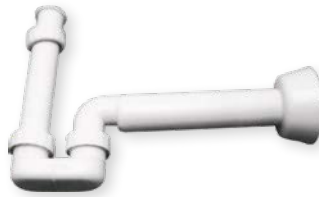

07104.000	1"1/4x40	9,950	30
-----------	----------	-------	----

art. 7106

Sifone S pesante tipo Geberit per lavabo in pp. bianco.



07106.000	1"1/4x40	17,014	30
-----------	----------	--------	----

art. 7108

Sifone ribassato pesante tipo Geberit per bidet in pp. bianco.



07108.000	1"1/4x40	17,014	30
-----------	----------	--------	----

art. 1125

Sifone a colonna in polipropilene orientabile, colore bianco s/piletta.

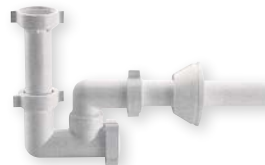

01125.002	1"1/4	9,738	10
-----------	-------	-------	----

art. 1126

Sifone a bottiglia in polipropilene, colore bianco s/piletta.



01126.002	1"1/4	5,336	10
-----------	-------	-------	----

art. **1518** **XLIRA**

Sifone Spazio Bagno per lavabo "LIRA"
 Ø32 - Ø40 - att. 1" - 1"1/4



cod. art.	mis.	€	conf.
01518.001	Ø32/40 1" - 1"1/4	19,809	10



art. **1518N** **XLIRA**

Sifone Spazio bagno NT per lavabo "LIRA"
 Ø 32 - 40 Att. 1" - 1"1/4



1518N.NT1	Ø32/40 1"-1"1/4	26,402	10
-----------	-----------------	--------	----

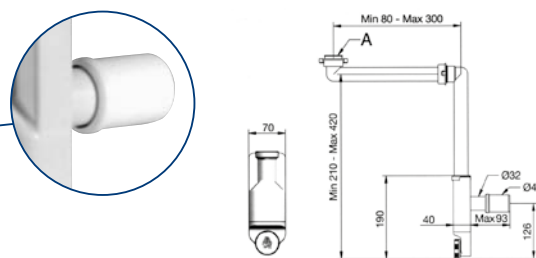

art. **1869** **XLIRA**

Sifone Spazio bagno giunto fisso per lavabo "LIRA"
 Ø 32 - 40 Att. 1" - 1"1/4



01869.000	Ø32/40 1"-1"1/4	21,050	10
-----------	-----------------	--------	----

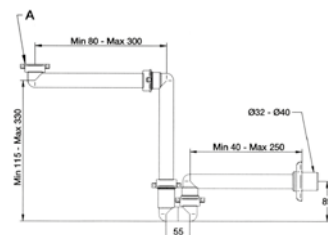

art. **1870** **XLIRA**

Sifone eccentrico per lavabi e bidet "LIRA"
 Ø 32 - 40 Att. 1" - 1"1/4



01870.000	Ø32/40 1"-1"1/4	18,085	10
-----------	-----------------	--------	----

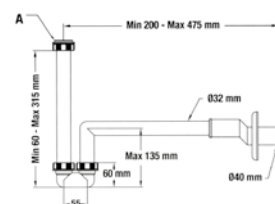

art. **1872** **XLIRA**

Piletta per lavabo completa di guarnizioni e tappo chiusura No problem "LIRA"
 Ø 45 Att. 1"1/2 x 1"1/4



01872.000	Ø45 1"1/2x1"1/4	43,761	10
-----------	-----------------	--------	----

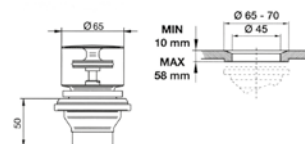

art. **1521** **XLIRA**

Sifone eccentrico per bidet tubo Ø 32-40 att. 1" - 1"1/4.



01521.000	Ø32/40 1" - 1"1/4	17,591	10
-----------	-------------------	--------	----



art. 378A

Piletta STP senza dado e codolo.



cod. art.	mis.	€	conf.
0378A.001	1"	11,982	10
0378A.002	1"1/4	15,407	10

art. 378AG

 Piletta lavabo S.T.P.
in ottone giallo grezzo

378AG.001	1"	12,807	10
378AG.002	1" 1/4	14,375	10

art. 379

 Piletta senza dado e codolo per lavabo,
C.T.P.

00379.001	1"	11,399	10
00379.002	1"1/4	13,793	10

art. 1527

Piletta lavabo in ottone cromato

1"1/4 Ø 63:

- il meccanismo di apertura risiede tutto all'interno del tappo ed è azionabile con un semplice "Click";
- controdado cilindrico con troppo pieno.



01527.000	1"1/4	31,547	10
1527A.STP	1"1/4	31,547	10

art. 1527A

Idem senza troppo pieno 1"1/4 Ø 63.

art. 1527X

 Piletta "Click- Clack" ottone cromato Lux
1"1/4 tappo grande senza troppo pieno,

1527X.CRO		31,547	10
-----------	--	--------	----

art. 1527X

 Piletta "Click- Clack" ottone cromato Lux
1"1/4 tappo grande con troppo pieno.

1527X.CTP		31,547	10
-----------	--	--------	----

art. 1527U

 Piletta "Click- Clack" 1"1/4 ottone cromato
universale.

1527U.000	1"1/4	27,099	10
-----------	-------	--------	----

art. **1698N**

Piletta click clack tonda nera opaca universale.

art. **1698B**

Piletta click clack tonda bianca opaca universale.

art. **1698A**

Piletta click clack tonda acciaio spazzolato universale.

art. **1698Z**

Piletta click clack tonda bronzo universale.

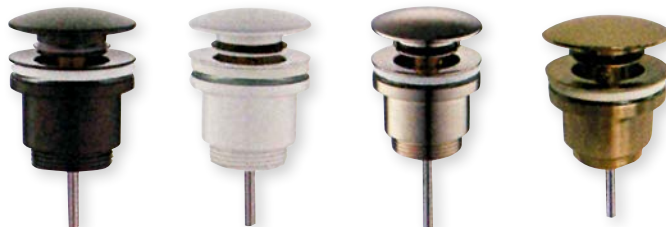

cod. art.	mis.	€	conf.
1698N.000	1"1/4	31,280	1
1698B.000	1"1/4	31,280	1
1698A.000	1"1/4	33,365	1
1698Z.000	1"1/4	33,365	1

art. **1699Q**

Piletta click clack quadrata nera opaca universale.



1699Q.000	1"1/4	38,584	1
------------------	-------	---------------	---

art. **1699**

Piletta click clack quadrata cromata universale.



01699.000		30,113	5
------------------	--	---------------	---

art. **1700L**

Piletta click clack tonda cromata senza troppo pieno.



1700L.100	100 mm	31,280	10
1700L.150	150 mm	37,533	10

art. **1701L**

Piletta click clack tonda cromata con troppo pieno.



1701L.100	100 mm	31,280	10
------------------	--------	---------------	----

art. 1527R

Tappo ricambio tondo per pilette Click Clack per nostri articoli (1527 - 1527A - 1527U).



cod. art.	mis.	€	conf.
1527R.000	Ø 66	11,482	10

art. 1527M

Meccanismo per piletta Click Clack.



1527M.000		8,620	10
------------------	--	--------------	----

art. 1527G

Guarnizione per tappi piletta Click Clack conf. (x 5pz).



1527G.000		4,604	1
------------------	--	--------------	---

art. 3933A

Piletta scarico libera cromata con troppo pieno.



3933A.CTP	1"1/4	24,646	10
------------------	-------	---------------	----

art. 3933B

Piletta scarico libera cromata senza troppo pieno.



3933B.STP	1"1/4	24,646	10
------------------	-------	---------------	----

art. 3931

Piletta automatica in ottone cromato, con comando a leva con tappo copripiletta 1"1/4 Ø 63.



03931.000	1"1/4	41,756	10
------------------	-------	---------------	----

art. **3935**

Piletta passante per lavabo con troppo pieno tondo realizzata in pezzo unoco, con tubo estensibile saldato all'estremità. Griglia troppo pieno in ABS. Materiale: Polipropilene PP - Colore: Bianco



cod. art.	mis.	€	conf.
03935.000		9,513	10

art. **3936**

Set di collegamento in ottone cromato C.T.P. Ø 70 H. 30.



03936.SET	Ø 70	37,291	1
-----------	------	--------	---

art. **3937**

Anello separatore in ottone cromato Ø 70 H. 25.



03937.ANL	Ø 70	26,303	1
-----------	------	--------	---

art. **1045**

Scarico automatico per batterie lavabo e bidet in ottone cromato spazzolato. **MADE IN ITALY**



01045.001	1"	20,561	25
01045.002	1"1/4	20,561	25

art. **1045X**

Scarico automatico per batterie lavabo e bidet. **IMPORT**



1045X.001	1"	14,612	10
1045X.002	1"1/4	14,612	10

art. **3939**

Asta per scarico automatico, lunghezza cm 30.



03939.001	cm 20	1,176	10
03939.002	cm 30	1,801	10
3939G.000		2,696	10

art. **3939G**

Dado e guarnizione per asta scarico.



art. 3939C

Asta di ricambio completa per piletta scarico automatico.

art. 1046

Asta per scarico automatico per lavabo.

art. 1046

Snodo (reggiasta) in metallo per scarico automatico.

art. 1046R

Snodo doppio snodato in ottone cromato per scarico automatico.

art. 1047

Asta e centralina per scarico automatico per bidet.

art. 1048

Tappo per scarico automatico.

art. 1048ANT

Tappo per scarico automatico Antivandalo.

art. 1048P

Tappo saltarello in plastica cromato **IMPORT**



cod. art.	mis.	€	conf.
-----------	------	---	-------

3939C .KIT		4,180	10
-------------------	--	--------------	----

01046 .000		6,670	10
-------------------	--	--------------	----

01046 .R01	reggiasta	1,739	10
-------------------	-----------	--------------	----

1046R .R02		1,876	10
-------------------	--	--------------	----

01047 .000		17,726	10
-------------------	--	---------------	----

01048 .001	1" Ø 33	6,065	20
-------------------	---------	--------------	----

01048 .002	1"1/4 Ø 40	6,366	20
-------------------	------------	--------------	----

01048 .ANT	1"1/4 Ø 40	6,417	20
-------------------	------------	--------------	----

1048P .000	1" Ø 35	2,501	20
-------------------	---------	--------------	----

1048P .001	1"1/4 Ø 40	2,668	20
-------------------	------------	--------------	----

art. **1048R**

Anelli O-ring per tappi saltarelli.



cod. art.	mis.	€	conf.
1048R.100	1" int 27,5 x 3	0,556	100
1048R.114	1"1/4 int 31 x 3	0,556	100

art. **1049**

Tappo copripiletta gigante universale per lavabo e bidet.



01049.001	1" Ø 62	15,007	6
01049.002	1"1/4 Ø 62	13,145	6

art. **1049V**

Tappo copripiletta gigante universale per vasca.



1049V.VAS	Ø 72	14,606	6
------------------	------	---------------	---

art. **453.R03**

Tappo ricambio per vasca.



00453.R03	Ø 42,5	6,083	6
------------------	--------	--------------	---

lampareto

art. **7112** 

Tappi in acciaio inox a scatto cromato con dispositivo di aggancio universale per pilette con CTP sia da 1" che 1"1/4 Ø 64.

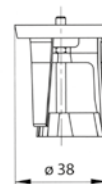
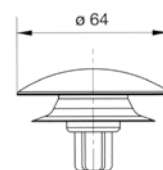

07112.000	1" e 1"1/4	32,152	10
------------------	------------	---------------	----

art. 7112A

Tappo saltarello universale click-clack in ottone cromato.



cod. art.	mis.	€	conf.
7112A.OTT	1"1/4	16,896	10

art. 7113 

Tappo in ottone cromato per vasca, adatto per colonna automatica guasta o difettosa Ø 74.

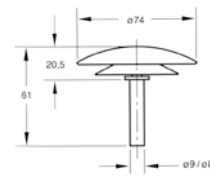

07113.000	Ø 74	34,362	10
------------------	------	---------------	----

art. 367

Sifone moplen a 1 via con piletta, uscita 32.



00367.000	1"1/4	9,893	30
------------------	-------	--------------	----

art. 368

Sifone moplen a 1 via senza piletta, uscita 32.



00368.000	1"1/4	6,670	30
0368A.000	1"1/2	6,670	30

art. 368/A

Sifone moplen a 1 via senza piletta, uscita 32.

art. 369

Sifone moplen a 2 vie con piletta, uscita 32.



00369.000	1"1/4	17,285	30
------------------	-------	---------------	----

art. 370

Sifone moplen a 2 vie senza piletta, uscita 32.



cod. art.	mis.	€	conf.
00370.000	1"1/4	8,198	30
0370A.000	1"1/2	8,198	30

art. 370A

Sifone moplen a 2 vie senza piletta, uscita 32.

art. 371

Sifone moplen a 1 via con piletta a attacco lavatrice, uscita 32.



00371.000	1"1/4	10,560	30
-----------	-------	---------------	----

art. 372

Sifone moplen a 1 via senza piletta e con attacco lavatrice, uscita 32.



00372.000	1"1/4	7,948	30
0372A.000	1"1/2	7,948	30

art. 372A

Sifone moplen a 1 via senza piletta e con attacco lavatrice, uscita 32.

art. 373

Sifone moplen a 2 vie con piletta e attacco lavatrice, uscita 32.



00373.000	1"1/4	16,807	30
-----------	-------	---------------	----

art. 374

Sifone moplen a 2 vie senza piletta e con attacco lavatrice, uscita 32.

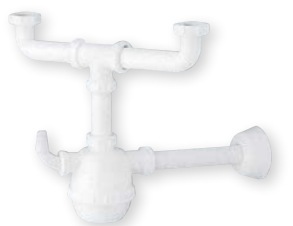

00374.000	1"1/4	9,393	30
0374A.000	1"1/2	9,393	30

art. 374A

Sifone moplen a 2 vie senza piletta e con attacco lavatrice, uscita 32.

art. 375

Piletta moplen senza troppo pieno per lavelli in acciaio inox.



00375.000	1"1/2	5,380	50
-----------	-------	--------------	----

art. 375A

Piletta moplen per lavelli in ceramica.

art. 375B

Piletta moplen per lavelli in ceramica.



0375A.000	1"1/4	4,011	50
0375B.000	1" 1/2	4,090	50

art. 376

Piletta moplen con troppo pieno per lavelli in acciaio inox.

art. 376T

Piletta moplen con troppo pieno tondo per lavelli in acciaio inox.

art. 1520

Piletta PP, C.T.P. per lavelli acciaio inox con tubo flessibile.

art. 1500

Sifone Eurolux fiasco PP 1 via. Scarico Ø 40.

art. 1502

Sifone Eurolux fiasco PP 2 vie. Scarico Ø 40.

art. 1504

Sifone Eurolux fiasco PP 1 via, con attacco lavatrice. Scarico Ø 40.



cod. art.	mis.	€	conf.
00376.000	1"1/2	10,282	10
0376T.000	1"1/2	10,282	10

01520.000	1"1/2	11,515	10
-----------	-------	---------------	----

01500.000	1"1/2	6,703	20
-----------	-------	--------------	----

01502.000	1"1/2	10,727	20
-----------	-------	---------------	----

01504.000	1"1/2	7,781	20
-----------	-------	--------------	----

art. **1506**

Sifone Eurolux fiasco PP 2 vie, con attacco lavatrice. Scarico Ø 40.



cod. art.	mis.	€	conf.
01506.000	1"1/2	11,477	20

art. **1508**

Sifone Eurolux PP linea 1. Scarico Ø 40.



01508.000	1"1/2	12,617	20
-----------	-------	---------------	----

art. **1510**

Sifone Eurolux PP linea 2. Scarico Ø 40.



01510.000	1"1/2	18,730	20
-----------	-------	---------------	----

13

art. **1512**

Sifone Eurolux PP 1 via, nella confezione è compreso un tappo per escludere l'attacco lavatrice. Scarico Ø 40.



01512.000	1"1/2	10,060	20
-----------	-------	---------------	----

art. **1514**

Sifone Eurolux PP 2 vie, nella confezione è compreso un tappo per escludere l'attacco lavatrice. Scarico Ø 40.



01514.000	1"1/2	14,729	20
-----------	-------	---------------	----

art. **1517 XLIRA**
Sifone livello **SPAZIO 1** Lira.



cod. art.	mis.	€	conf.
01517.001	1"1/2	20,083	30



art. **1519 XLIRA**
Sifone livello salva **SPAZIO 2** Lira.



01519.000	1"1/2	29,416	17
-----------	-------	---------------	----



art. **1519N XLIRA**
Sifone livello **NEW SPAZIO 2** Lira.



1519N.000	1"1/2	29,416	17
-----------	-------	---------------	----



art. **1523 XLIRA**
Sifone **SPAZIO 2NT** ispezionabile "LIRA"

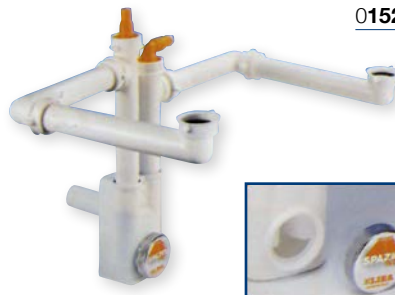

01523.000	1"1/2	43,019	20
-----------	-------	---------------	----



art. **1516 XLIRA**
Piletta Basket CTP
per lavelli inox "LIRA"
1"1/2 x Ø115



01516.000		56,833	10
1516T.000		80,140	10

art. **1516T XLIRA**
Piletta Basket CTP TONDO
per lavelli inox "LIRA"

art. **1515** **XLIRA**

Piletta Basket STP
per lavelli inox "LIRA" 1"1/2 x Ø115.



cod. art.	mis.	€	conf.
01515.000		42,262	10

art. **1515R** **XLIRA**

Cestello ricambio "LIRA".



1515R.000		27,258	20
-----------	--	--------	----

art. **1515G** **XLIRA**

Guarnizione gomma per cestello
BASKET "LIRA"



1515G.000		5,229	10
-----------	--	-------	----

art. **1496** **XLIRA**

Tappo di ricambio "LIRA".



01496.000		25,578	10
-----------	--	--------	----

art. **1497** **XLIRA**

Cestello ricambio "LIRA".



01497.000		13,573	10
-----------	--	--------	----

art. **1493** **XLIRA**

Salterello con pomolo cromato per lavelli
inox, sintetici e ceramica STP "LIRA".



01493.000		95,892	1
-----------	--	--------	---

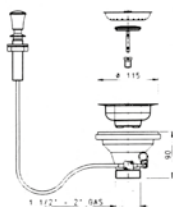

art. 1494 XLIRA

Salterello con pomolo cromato per lavelli inox, sintetici e ceramica CTP rettangolare "LIRA".

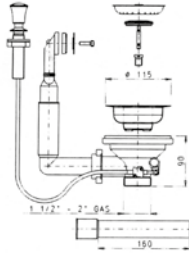

cod. art.	mis.	€	conf.
01494.000		110,282	1

art. 1495 XLIRA

Salterello con pomolo cromato per lavelli inox, sintetici e ceramica CTP tondo "LIRA".

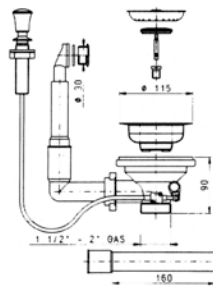

01495.000		126,272	1
-----------	--	---------	---

art. 1695 XLIRA

Per lavelli inox con foro Ø 60 con troppo pieno - uscita 1/2". Lira.

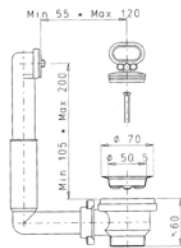

01695.000		16,791	10
-----------	--	--------	----

art. 1696 XLIRA

Per lavelli inox con foro Ø 60 senza troppo pieno - uscita 1/2". Lira.



01696.000		11,205	10
-----------	--	--------	----

art. 1697 XLIRA

Per lavelli in ceramica con foro Ø 60 "Gattinara" - uscita 1/2". Lira.



01697.000		9,387	10
-----------	--	-------	----

art. **723** **XLIRA**
Tappo maniglia Lira



cod. art.	mis.	€	conf.
00723.045	Ø 45	3,646	10
00723.050	Ø 50,5 standard	3,646	10

art. **1522**
Riduzione in PP filettata bianca.



01522.001	F 1"1/4 x M 1"1/2	0,875	50
01522.002	F 1" x M 1"1/4	0,875	50

art. **1522E**
Riduzione in PP filettata bianca.



1522E.001	M 1"1/2 x F 1"1/4	0,875	25
1522E.002	M 1"1/4 x F 1"	0,875	25

art. **1524**
Riduzione PP filettata bianca.



01524.001	F 1"1/2 x M 1"1/4	0,875	50
01524.002	F 1"1/4 x M 1"	0,875	50

art. **1539C**
Griglietta cromata in ABS per lavabo/bidet.



1539C.LAV	Ø 60	2,568	10
1539C.BID	Ø 60	2,568	10

art. **1539L**
Griglietta cromata in ABS per lavelli cucina.

1539L.000	Ø 80	3,168	10
-----------	------	--------------	----

art. **1539**
Cestello grigliato universale.
Materiale: PP polipropilene.
Colore: bianco.



01539.000		0,805	100
-----------	--	--------------	-----

art. **1537**
Piletta Gigante per lavelli con foro Ø 90 mm. S carico filettato da 1"1/2. Corpo piletta in polipropilene PP bianco, flangia e cestello in acciaio inox 18/8 Ø 115. Versione senza troppo pieno.



01537.000	1"1/2	16,397	5
-----------	-------	---------------	---

art. **1537B** **bonomini**
Piletta Gigante "canestro" per lavelli con foro Ø 90 mm. S carico filettato da 1"1/2. Corpo piletta in polipropilene PP bianco versione senza troppo pieno.



1537B.000	1"1/2	24,761	5
-----------	-------	---------------	---

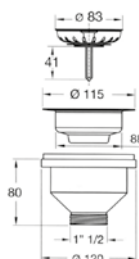

art. 1538

Piletta Gigante per lavelli con foro Ø 90 mm. (3"1/2). Scarico filettato da 1"1/2. Corpo piletta in polipropilene PP bianco, flangia e cestello in acciaio inox 18/8 Ø 115.
Versione con troppo pieno flessibile dotato di griglia rettangolare in acciaio inox per lavelli in resina.



cod. art.	mis.	€	conf.
01538.000	1"1/2	19,614	5
1538T.000	1"1/2	23,260	5

art. 1538T

Piletta Gigante per lavelli con foro Ø 90 mm. (3"1/2). Scarico filettato da 1"1/2. Corpo piletta in polipropilene PP bianco, flangia e cestello in acciaio inox 18/8 Ø 115.
Versione con troppo pieno flessibile dotato di griglia tonda in acciaio inox per lavelli in resina.

art. 1538B 

Piletta "canestro" per lavelli con foro da ø 90 mm (3"1/2) scarico filettato da 1"1/2 con troppo pieno

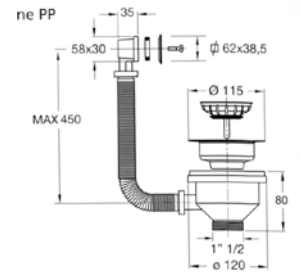

1538B.QUA	1"1/2	29,458	5
-----------	-------	--------	---

art. 1538B TON 

Piletta "canestro" per lavelli con foro da ø 90 mm (3"1/2) scarico filettato da 1"1/2 con troppo pieno

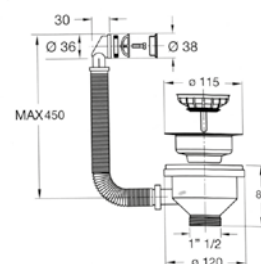

1538B .TON	1"1/2	29,638	5
------------	-------	--------	---

art. 1537C

Cestello ricambio per pilette giganti

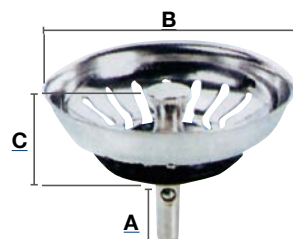

1537C.000	UNIVERSALE (FRANKE)	6,003	10
A 30 mm B 82 mm C 22 mm			
1537C.001	UNIVERSALE (BASSO)	5,883	10
A 30 mm B 82 mm C 9,5 mm			
1537C.BON	BONOMINI	11,045	10
A 40 mm B 82 mm C 20 mm			
1537C.OMP	OMP	14,076	10
A 32 mm B 82 mm C 19 mm			
1537C.MAR	MARYPLAST	5,148	10
A 19 mm B 82 mm C 20 mm			
1537C.GFB		25,011	10
A 32 mm B 79 mm C 23 mm			

BREVETTATO

art. **1860**
Espositore scattino
pz 18



SCATTINO

art. **1861**
Scattino singolo



cod. art.	mis.	€	conf.
01860.STC		115,052	1x18 pz
01861.STC	Ø 50	6,773	1 pz



Basta una lieve pressione per chiuderlo e aprirlo, permettendo così sempre la stessa altezza di apertura



Funziona anche con l'aiuto di un utensile



Scatta anche in presenza del tappetino di gomma

art. **1515V**
Vite ricambio per piletta basket LIRA



1515V.001	H 42	12,711	10
1515V.002	H 61	15,095	10
1515V.003	H 85	16,911	10

art. **1537V**
Vite ricambio per piletta gigante
per ns articolo 1537 e 1538

1537V.001	H 45	4,202	10
1537V.002	H 66	6,781	10

art. **1538V**
Vite ricambio per piletta gigante
BONOMINI per ns articolo 1537B e 1538B

1538V.VIT	H 50	7,728	10
------------------	------	--------------	----

art. **1862V**
Vite ricambio in plastica per piletta gigante
per ns articolo 1862 - 1864 - 1865 - 1866

1862V.VIT	H 35	1,217	10
------------------	------	--------------	----

art. **1862**
Pilettone Scattino 3" 1/2
senza troppo pieno

BREVETTATO



01862.STC	Racc. 1"1/2	11,735	50
-----------	-------------	---------------	----

art. 1864

 Pilettoni Scattino 3" 1/2
 con troppo pieno

BREVETTATO

cod. art.	mis.	€	conf.
01864.STC	Racc. 1"1/2	14,606	50

art. 1865

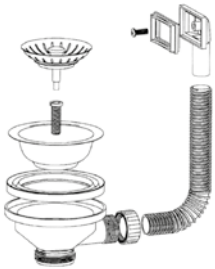
 Pilettoni Scattino 3" 1/2
 con troppo pieno flessibile

BREVETTATO

01865.STC	Racc. 1"1/2	15,547	50
-----------	-------------	--------	----

art. 1866

 Pilettoni Scattino 3" 1/2
 con troppo pieno rotondo

BREVETTATO

01866.STC	Racc. 1"1/2	13,526	50
-----------	-------------	--------	----

art. 381A

 Pilettoni sifoide lavello C.T.P. e senza dado
 e codulo.

art. 381B

Idem S.T.P.



0381A.000	1"1/4	29,744	8
0381B.000	1"1/4	31,601	8

art. **383**

Pilettone con griglia, codulo diritto in tubo.



cod. art.	mis.	€	conf.
00383.000	1"1/4	14,760	10

art. **384A**

Piletta Gattinara senza dado e codolo.



0384A.000	1"1/4	13,014	8
-----------	-------	--------	---

art. **386A**

Pilettone sifoide, piatto doccia senza dado e codolo.



0386A.000	1"1/4	23,733	8
-----------	-------	--------	---

art. **386S**

Solo griglia per pilettone sifoide.



0386S.000	1"1/4	9,444	10
-----------	-------	-------	----

13

art. **387**

Pilettone sifoide a pavimento.



00387.000	Ø 90	20,572	2
-----------	------	--------	---

art. **387A**

Pilettone sifoide a pavimento.



0387A.000	100x100	33,556	2
-----------	---------	--------	---

art. **388**

Piletta sifoide per piatto doccia, scarico alto codulo, Ø 32 1" 1/4.



00388.000		49,284	2
00388.GRI	griglia	6,804	10
0388B.000	Ø 40	43,283	2

art. **388B**

Idem con dado a stringere per inserto Ø 40.

art. 266

Campanine pesanti inox 18/8, alte per lavelli, basse per vasca.



cod. art.	mis.	€	conf.
00266.LAV		4,961	25
00266.VAS		3,667	25

art. 1122 

“Splash” pozzetto sifoide, per doccia, corpo in PEHD e piletta in plastica. Coperchio in ottone cromato. Scarico \varnothing 40 - 50 a saldare o innestare.

Materiale PEHD + ottone + ABS

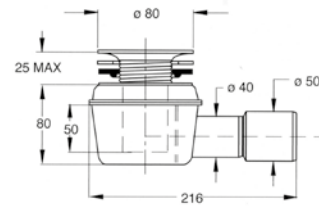

01122.002	\varnothing 80	26,999	25
01122.R01	griglia	10,960	10

art. 1123 

Piletta sifoide gigante per piatti doccia in PVC, piletta in ottone cromato, grigio interno \varnothing 40, esterno \varnothing 50, da incollare.



01123.002	\varnothing 80	22,968	25
-----------	------------------	---------------	----

art. 1122A 

“Splash” pozzetto sifoide, per doccia, corpo in pvc e piletta in plastica. Coperchio in ottone cromato. Scarico \varnothing 40 - 1”1/2
Materiale PVC + ottone

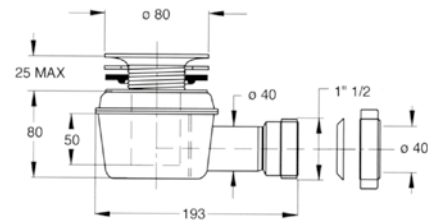

1122A.000	\varnothing 80	26,999	10
-----------	------------------	---------------	----

art. 1123A

Piletta a pozzetto per piatto doccia uscita a stringere \varnothing 40.



1123A.STR	\varnothing 80	14,062	25
-----------	------------------	---------------	----

art. **52** 

"Splash" pozzetto sifoide per doccia, corpo in pehd e piletta in plastica. Coperchio in ABS cromato. Scarico \varnothing 40-50 mm a saldare o innestare. Flangia piletta \varnothing 80 mm



cod. art.	mis.	€	conf.
00052.000	\varnothing 80 mm	18,604	25

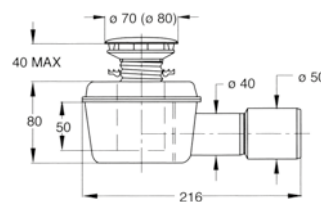

art. **53** 

"Splash" pozzetto sifoide per doccia, corpo in pp e piletta plastica. Coperchio in abs cromato. Scarico filetato da 1"1/2 con ghiera e guarnizione conica. Flangia piletta \varnothing 80 mm.



00053.000	\varnothing 80 mm	18,604	25
-----------	---------------------	---------------	----

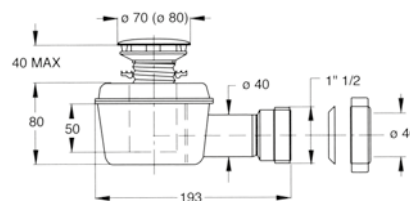

art. **715** 

Piletta sifonata per piatti doccia \varnothing 90 con griglia "Superlux" in ABS cromato.
 - griglia Superlux \varnothing 115 amovibile miglioramento estetico e rapidità di scarico (grazie ai fori di aerazione);
 - completamente ispezionabile: imbuto e cestello estraibili per la pulizia periodica;



00715.000		29,470	12
715IX.000		37,379	12
0715R.000		15,127	12

art. **715IX**

Idem con coperchio in acciaio inox

art. **715R**

Coperchio ricambio in ABS cromato

13

art. **716** 

Sifoni per piatti doccia foro 90 mm.



000716.000		29,291	10
------------	--	---------------	----

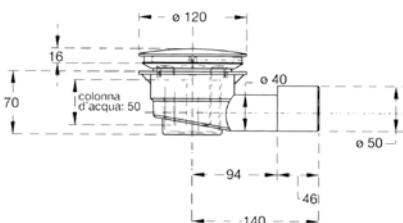

art. **718** 

Piletta per piatto doccia con sifone estraibile, altezza ridotta 65 mm PVC / ABS, coperchio cromato



000718.000	1" 1/2 \varnothing 40	17,905	10
------------	-------------------------	---------------	----

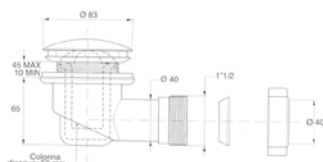

art. 719

Piletta piatto doccia a stringere ribassata senza piattello.

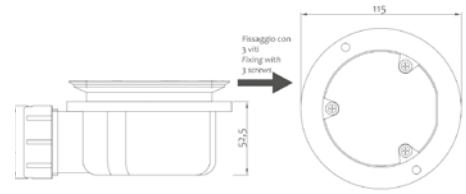

cod. art.	mis.	€	conf.
00719.000	1" 1/2 Ø40	25,795	10

art. 719CO

Piletta piatto doccia a stringere ribassata 3 viti con piattello.



719CO.000	1" 1/2 Ø40	28,110	10
-----------	------------	---------------	----



art. 724

Piletta sifonata in PP per piatto doccia con foro ø90

- griglia ø118 ABS cromato
- piletta ø115 POM
- uscita laterale 1"½
- ingombro sotto piatto doccia 70

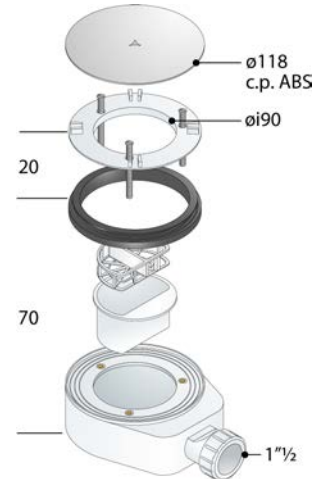

00724.000		25,795	10
-----------	--	---------------	----

art. 725

Piletta sifonata in PP per piatto doccia con foro ø90

- senza griglia
- piletta ø108 inox AISI316
- guarnizione piana per piatto doccia in ceramica
- uscita laterale 1"½
- ingombro sotto piatto doccia 70



00725.000		25,795	10
-----------	--	---------------	----





art. 726

Piletta sifonata in PP per piatto doccia con foro ø90

- griglia ø118 ABS cromato
- piletta ø110 POM
- uscita laterale liscia ø40
- ingombro sotto piatto doccia 60



cod. art.	mis.	€	conf.
00726.000		25,795	10

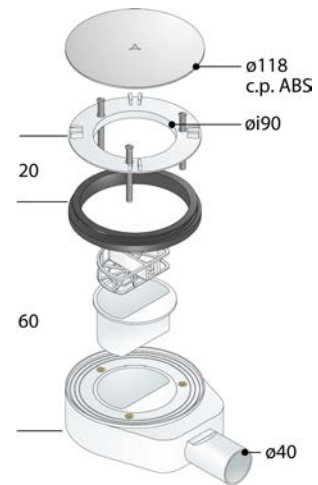

art. 727

Piletta sifonata in PP per piatto doccia con foro ø90

- senza griglia
- piletta ø108 inox AISI316
- guarnizione doppio labbro per piatto doccia in acrilico
- uscita laterale liscia ø40
- ingombro sotto piatto doccia 60



00727.000		25,795	10
-----------	--	--------	----

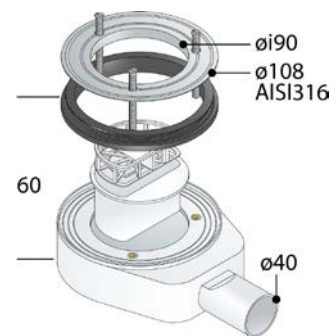

art. 728

N.R.V. Valvola antiodore
Versione per manichetta doccia pavimento da Ø75 mm a Ø80 mm.
Valvola meccanica di non ritorno anti-odore in silicone.

- Materiale:** ABS + Silicone
- Colore:** Bianco + Verde
- Applicazione:** bloccaggio degli odori
- Peso:** 0,043 Kg



00728.000		21,551	10
-----------	--	--------	----

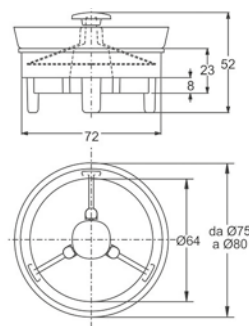

art. **835** TECNOLOGIE IDRAULICHE

Piletta sifonata per piatto doccia
foro \varnothing 90 ultra ribassata ispezionabile
coperchio rivestito in acciaio INOX

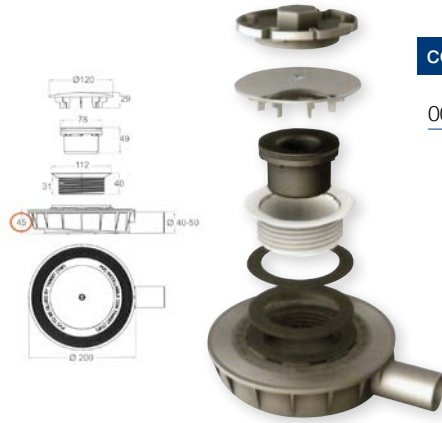

cod. art.	mis.	€	conf.
00835.000	\varnothing 40	68,955	10

art. **834** TECNOLOGIE IDRAULICHE

Pozzetto sifonato da pavimento
Ingombro ridotto - PVC+ABS+INOX

00834.000	10x10 cm	44,795	20
-----------	----------	--------	----

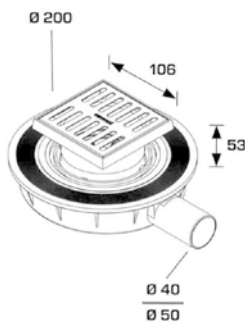

art. **833**

Set. doccia a canale mod. SQUARES
in ABS con griglia acciaio, sifone estraibile
per pulizie periodiche, sifonatura 3,5 cm,
piedino di regolazione per facilitare la posa.
Completo di telo PVC

00833.040	40 cm	168,908	1
00833.050	50 cm	191,251	1
00833.060	60 cm	223,098	1
00833.070	70 cm	252,528	1
00833.080	80 cm	288,093	1
00833.090	90 cm	318,682	1

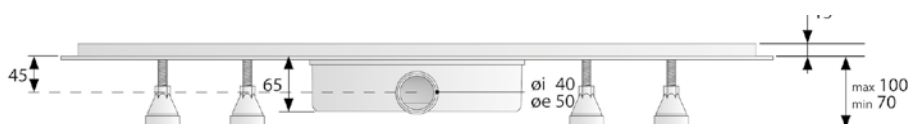
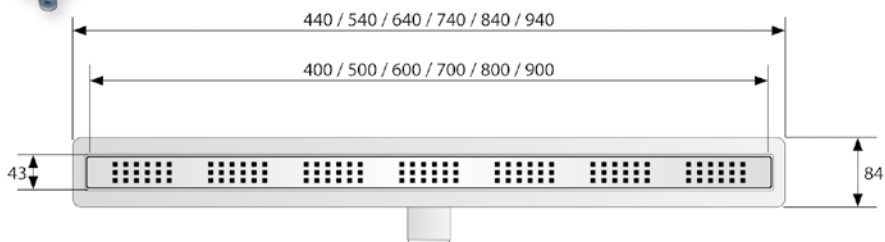



art. **905**

Set per doccia isolamento in PVC preassemblato in fabbrica



cod. art.	mis.	€	conf.
00905.120	1200x1200	104,004	6
00905.150	1500x1800	183,581	6
00905.180	1800x2000	207,554	6

art. **1124**



Pozzetto sifonato a pavimento con griglia cromata e manichetta regolabili, materiale in PVC, colore grigio da incollare, interno Ø 40, esterno Ø 50.



01124.000		29,146	10
01124.R01	griglia	19,100	10

art. **1132-OT**



Codolo curvo in PHED neri a saldare con dado in ottone da 1" 1/4 - 1" 1/2.



01132.OT1	1"1/4x40	8,689	10
01132.OT2	1"1/2x40	9,281	10

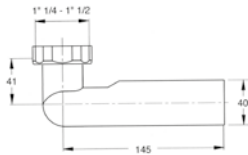

art. **1133-OT**



Codolo diritto in PHED neri a saldare con dado in ottone da 1" 1/4 - 1" 1/2.

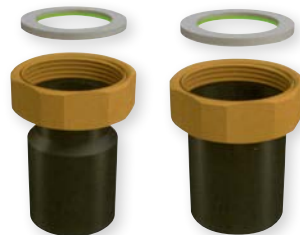

01133.OT1	1"1/4x40	8,689	10
01133.OT2	1"1/2x40	9,281	10

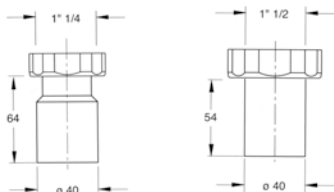

art. 889

Sifone ribassato orientabile con piletta Ø 80 per piatti doccia.

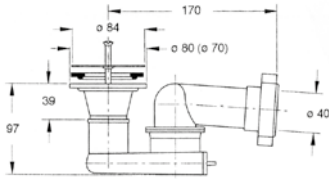

cod. art.	mis.	€	conf.
00889.000	Ø 80	21,647	10

art. 1526

Piletta, vasca, tappo e catenella, parti incasso PP e griglia acciaio, con tubo collegamento flessibile.



01526.000	1"1/2	14,778	10
-----------	-------	--------	----

art. 1528

Colonna vasca PP maniglia e tappo in ottone cromato.



01528.000	1"1/2	41,938	10
-----------	-------	--------	----

art. 1528A

Set colonna vasca PP LEO con sifone.

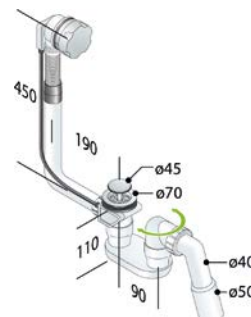

1528A.000		84,996	10
-----------	--	--------	----

art. **1529**  TECNOLOGIE IDRAULICHE
 Colonna vasca automatica Clic Clac.



cod. art.	mis.	€	conf.
01529.000	1"1/2	66,729	10

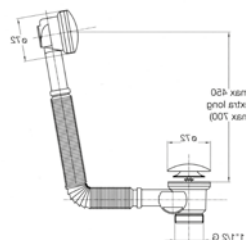

art. **453**
 Colonna scarico automatico senza dado e codulo. Cromata.



00453.000		74,783	1
00453.R01	maniglia	12,005	1
00453.R02	piletta	8,114	1
00453.R03	tappo	6,033	10
00454.000		68,697	1

art. **454**
 Colonna scarico automatico per vasca a sedere senza dado e codulo. Cromata.

art. **456**
 Colonna scarico automatico con erogazione al T.P. senza dado e codulo. Cromata.



00456.000		129,457	1
-----------	--	----------------	---

art. **456PL**
 Colonna scarico per vasca con bocca di erogazione al troppo pieno, tubo corrugato e scarico in PP
 - trasmissione con movimento "direct"
 - bocca di erogazione "clean" in ABS
 - differenti lunghezze fino a 125 cm.



456PL.000	1"1/2	85,871	1
-----------	-------	---------------	---

art. 710-0T

Sifone ribassato orientabile per colonne vasca, PHED nero da 1" 1/2, dado in ottone a saldare, interno Ø 40, esterno Ø 50.



cod. art.	mis.	€	conf.
7100T.000		14,952	10

art. 712

Sifone ribassato orientabile per vasca Ø 40 a stringere.

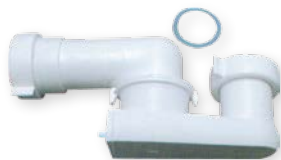

00712.000	1"1/2	12,725	10
------------------	-------	---------------	----

art. 897

Pozzetto a pavimento in polipropilene a quattro vie a guarnizione, colore grigio, tre vie di ricevimento, Ø 40 e una via di scarico Ø 50, altezza mm.120.



00897.000	h. 120	11,116	5
00899.000	h. 170	13,200	5

art. 899

Idem altezza mm. 170.

art. 460

Tappo per sifone ad espansione.



00460.001	Ø 80	6,392	15
00460.002	Ø 90	6,674	15
00460.003	Ø 100	6,114	15
00460.004	Ø 120	6,114	5

art. 461

Tappo per sifone ad espansione con inbuto e griglia.



00461.001	Ø 90	8,632	6
00461.002	Ø 100	8,632	6
00461.003	Ø 120	16,674	1

art. **459**

Piastra per coprisifone in acciaio inox s/vite.



cod. art.	mis.	€	conf.
00459.001	Ø 130	2,873	10
00459.002	Ø 140	2,873	10
0459F.000	Ø 130	3,057	10

art. **459/F**

Idem forata Ø 130.

art. **459VT**

Vite in metallo cromato per piattello o pilette



	per piattello		
459VT.035	M6x35	0,424	10
459VT.075	M6x75	1,070	10
459VT.100	M6x100	1,945	10

art. **72**

Chiusini sifonati in materiale antiurto Con scarico laterale.



00072.001	cm10x10 Ø40	14,381	10
00072.002	cm15x15 Ø50	26,817	10

art. **73**

Chiusini sifonati in materiale antiurto.



00073.001	cm10x10 Ø4	6,322	10
00073.002	cm15x15 Ø5	9,449	10
00073.003	cm20x20 Ø8	16,535	10
00073.004	cm25x25 Ø10	29,582	10
00073.005	cm30x30 Ø10	52,092	10